



RECORD THIS INFORMATION FOR FUTURE REFERENCE:

Model Number _____
Serial Number _____
ADB Model Number _____
ADB Serial Number _____
Date Purchased _____

INSTALLATION INSTRUCTIONS

Roof Top Unit (Quiet Zone Ducted Application)				
Description	Blizzard NXT™ Model	Board Built In	Thermostat	Optional Indoor Temperature Sensor
Air Conditioner				
CCC 2 Controls	H541815A H541816A	Board Built In	3314082.000 CCC 2-Blk 3314082.011 CCC 2-Wht	3311931.000-20' 3311931.012-40' 3311931.020-60'
LCD SZ Controls	H541915A H541916A	Board Built In	3313192.000 C/F-Wht 3313192.019 C/F-Blk	N/A
Heat Pump				
CCC 2 Controls	H551816A	Board Built In	3314082.000 CCC 2-Blk 3314082.011 CCC 2-Wht	3311931.000-20' 3311931.012-40' 3311931.020-60'
LCD SZ Controls	H551916A	Board Built In	3313193.000 C/F/HP-Wht 3313193.017 C/F/HP-Blk	N/A

This Unit is designed for OEM installation. All initial installations must be approved by Dometic Corporation.



Read these instructions carefully. These instructions **MUST** stay with this product.

REVISION B
Form No. 3316201.000 11/17
(French 3316202.000_B)
©2017 Dometic Corporation
LaGrange, IN 46761

USA
SERVICE OFFICE
Dometic Corporation
1120 North Main Street
Elkhart, IN 46514

SERVICE CENTER &
DEALER LOCATIONS
Please Visit:
www.eDometic.com

INTRODUCTION

This air conditioner/heat pump (hereinafter referred to as “unit” or “product”) is designed and intended for installation on the roof of a Recreational Vehicle (hereinafter referred to as RV) during the time it is manufactured.

Read these instructions and highlight the appropriate steps for your particular procedure before starting the installation.

This unit can be installed by one person with brief help from additional personnel. Use these instructions to ensure a properly installed, and properly functioning product.

Dometic Corporation reserves the right to modify appearances and specifications without notice.

TABLE OF CONTENTS

INTRODUCTION.....	2
DOCUMENT SYMBOLS	2
IMPORTANT SAFETY INSTRUCTIONS.....	3
A. Recognize Safety Information	3
B. Understand Signal Words.....	3
C. Supplemental Directives.....	3
D. General Safety Messages	3
SPECIFICATIONS.....	4
A. Table - Unit Data.....	4
B. Roof Requirements.....	4
C. Table - Air Distribution Duct Sizing & Design.....	4
INSTALLATION INSTRUCTIONS	5
A. Choosing Proper Location For Unit.....	5
B. Roof Preparation	5
C. Air Distribution Duct Sizing & Design	6
D. Wiring Requirements	8
E. Choosing Thermostat Location.....	9
F. Thermostat, Optional Indoor Temperature Sensor & Thermostat Communication Cable Installation	9
G. Placing Unit On Roof.....	11
H. (CCC 2 System Only) Configuration.....	11
I. 120 Vac Power Supply Connection	12
J. LCD SZ System Low Voltage Wire Connections.....	14
K. CCC 2 System Low Voltage Wire Connections.....	14
L. Securing Unit To Roof.....	14
M. (LCD SZ System Only) System Checkout.....	16
N. (CCC 2 System Only) Reset & Checkout.....	16
O. (CCC 2 System Only) Furnace/Aqua Temperature Differential Setting.....	16
GENERAL INFORMATION.....	17
A. Heat Gain	17
B. Condensation	17
WIRING DIAGRAMS.....	18
A. Simple RV Wiring Diagram.....	18
B. Unit Wiring Diagrams.....	19

DOCUMENT SYMBOLS

 Indicates additional information that is **NOT** related to physical injury.

 Indicates step-by-step instructions.

IMPORTANT SAFETY INSTRUCTIONS

This manual has safety information and instructions to help users eliminate or reduce the risk of accidents and injuries.

A. Recognize Safety Information



This is the safety alert symbol. It is used to alert you to potential physical injury hazards. Obey all safety messages that follow this symbol to avoid possible injury or death.

B. Understand Signal Words

A signal word will identify safety messages and property damage messages, and will indicate the degree or level of hazard seriousness.

WARNING indicates a hazardous situation that, if **NOT** avoided, could result in death or serious injury.

CAUTION indicates a hazardous situation that, if **NOT** avoided, could result in minor or moderate injury.

NOTICE is used to address practices **NOT** related to physical injury.

C. Supplemental Directives



Read and follow all safety information and instructions to avoid possible injury or death.

Read and understand these instructions before [installing / using / servicing / performing maintenance on] this product.

Incorrect [installation / operation / servicing / maintaining] of this product can lead to serious injury. Follow all instructions.



The installation **MUST** comply with all applicable local or national codes, including the latest edition of the following standards:

U.S.A.

- ANSI/NFPA70, National Electrical Code (NEC)
- ANSI/NFPA 1192, Recreational Vehicles Code

CANADA

- CSA C22.1, Parts I & II, Canadian Electrical Code
- CSA Z240 RV Series, Recreational Vehicles

D. General Safety Messages

WARNING Failure to obey the following warnings could result in death or serious injury:

- This product **MUST** be [installed / serviced] by a qualified service technician.
- Do **NOT** modify this product in any way. Modification can be extremely hazardous.
- Do **NOT** add any devices or accessories to this product except those specifically authorized in writing by Dometic Corporation.

SPECIFICATIONS

A. Table - Unit Data

Model No.	Nominal Capacity (BTU HR) Cooling	Electrical Rating	Compressor Rated Load Amps	Compressor Locked Rotor Amps	Fan Motor Rated Load Amps	Fan Motor Locked Rotor Amps	Refrigerant R-410A (oz)	Minimum Wire Size*	AC Circuit Protection ***Installer Supplied	Minimum Generator Size** 1 Unit / 2 Units
H541815A72X	13,500	120 Vac 60 Hz 1 ph	12.7	68.0	2.8	8.0	19.5	12 AWG Copper Up to 24'	20 Amp	3.5 kW / 5.0 kW
H541816A72X	15,000		13.2	70.0	2.8	8.0	20.1		20 Amp	3.5 kW / 5.0 kW
H541915A72X	13,500		12.7	68.0	2.8	8.0	19.5		20 Amp	3.5 kW / 5.0 kW
H541916A72X	15,000		13.2	70.0	2.8	8.0	20.1		20 Amp	3.5 kW / 5.0 kW
H551816A72X	15,000		13.2	70.0	2.8	8.0	21.0		20 Amp	3.5 kW / 5.0 kW
H551916A72X	15,000		13.2	70.0	2.8	8.0	21.0		20 Amp	3.5 kW / 5.0 kW

* For wire length over 24 ft., consult the National Electrical Code for proper sizing.

** Dometic Corporation gives **GENERAL** guidelines for generator requirements. These guidelines come from experiences people have had in actual applications. When sizing the generator, the total power usage of your RV must be considered. Keep in mind generators lose power at high altitudes and from lack of maintenance.

*** CIRCUIT PROTECTION: Time Delay Fuse or Circuit Breaker Required.

B. Roof Requirements

- A 14-1/4" x 14-1/4" ($\pm 1/8$ ") square opening (hereinafter referred to as "roof opening") is required for installing this unit. This opening is part of the return air system of the unit and **MUST** be finished in accordance with NFPA 1192.
- Roof construction with rafters/joists support frames on a minimum of 16 inch centers.

C. Table - Air Distribution Duct Sizing & Design

Duct Cross Sectional Area	21.0 Sq. In. Min.
Duct Size Depth Width Total Duct Length Duct Length (short run)	1-1/2 In. Min. - 2-1/2 In. Max. 7.0 In. Min. - 10.0 In. Max. 15.0 Ft. Min. - 40.0 Ft. Max. 1/3 Total Duct Length
Register Requirements per A/C Unit Number Required Supply Register Free Air Area Return Register Free Air Area Distance From Duct End Distance From Elbow	4 Min. - 8 Max. 14.0 Sq. In. 40.0 Sq. In. 5.0 In. Min. - 8.0 In. Max. 15.0 In.
Total System Static Air Pressure Blower at High Speed, Filter & Grille In Place	0.55 - 1.10 In. W.C.

INSTALLATION INSTRUCTIONS

A. Choosing Proper Location For Unit

This unit is specifically designed for installation on the roof of an RV. When determining your cooling requirements, the following should be considered:

- Size of RV;
 - Window area (increases heat gain);
 - Amount of insulation in walls and roof;
 - Geographical location where the RV will be used;
 - Personal comfort level required.
1. For one unit installation: The unit should be mounted slightly forward of center (front to back) and centered from side to side.
 2. For two unit installations: Install one unit 1/3 and one unit 2/3's from front of RV and centered from side to side.

It is preferred that the unit be installed on a relatively flat and level roof section measured with the RV parked on a level surface. See table below for maximum acceptable tilt.

Model Number	Max Tilt (All Directions)
H541815A	15°
H541816A	
H541915A	
H541916A	
H551816A	
H551916A	

3. After Location Has Been Selected:
 - a. Check for obstructions in the area where unit will be installed. See (FIG. 1).

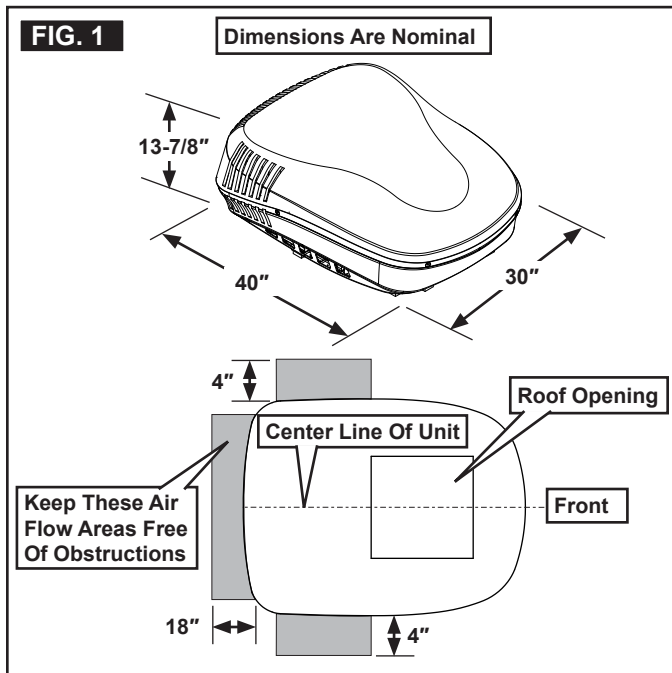

- b. **NOTICE** Maintain structural integrity. Otherwise damage to product and/or RV could occur.

The roof must be designed to support 130 pounds when RV is in motion. Normally a 200 lb. static load design will meet this requirement.

B. Roof Preparation

1. **WARNING** FIRE OR ELECTRICAL SHOCK HAZARD. Make sure there are no obstacles (wires, pipes, etc.) inside RV's [roof / floor / walls]. Shut **OFF** gas supply, disconnect 120 Vac power from RV, and disconnect positive (+) 12 Vdc terminal from supply battery **BEFORE** drilling or cutting into RV. Failure to obey these warnings could result in death or serious injury.

i Opening Requirements - Before preparing the ceiling opening, the type of system options **MUST** be decided upon. Read all of the following instructions before beginning the installation.

2. Carefully mark and cut the required roof opening. See "B. Roof Requirements" on page (4).
3. Using the roof opening as a guide, cut the matching hole in the ceiling.
4. **NOTICE** Maintain structural integrity. Otherwise damage to product and/or RV could occur.

NOTICE NEVER create a low spot on RV roof. Otherwise, water will pool and could cause a leak.

The opening created must be framed to provide adequate support and prevent air from being drawn from the roof cavity. Framing stock 3/4" or more in thickness must be used. Remember to provide an entrance hole for power supplies, indoor temperature sensor (if applicable), thermostat communication cable, and furnace wires (if applicable) at the front of the opening. See (FIG. 2).

INSTALLATION INSTRUCTIONS

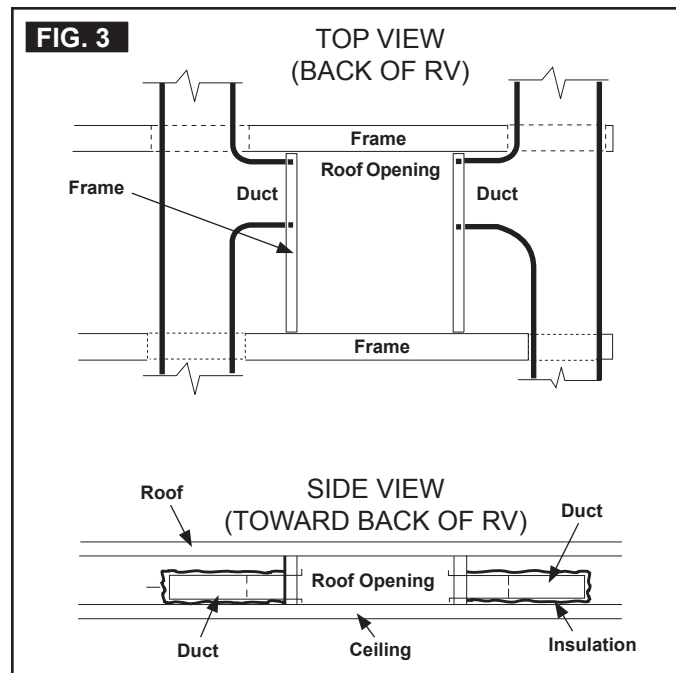
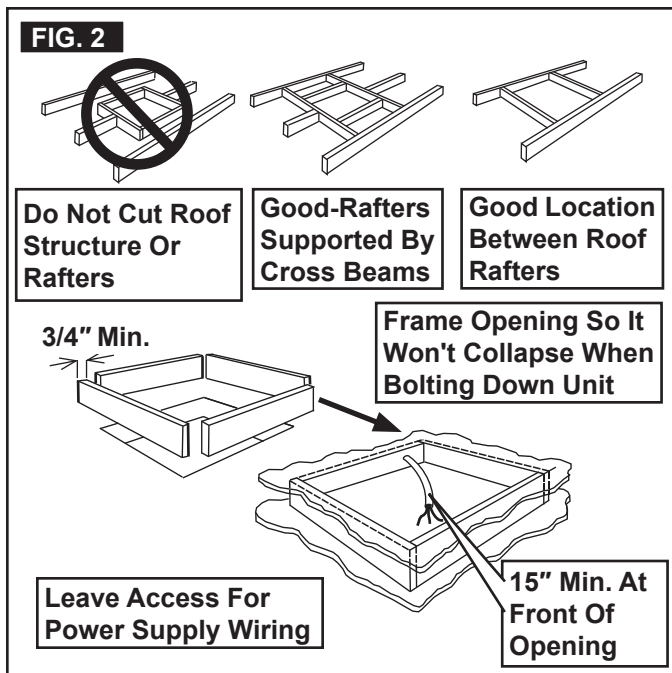

C. Air Distribution Duct Sizing & Design

The installer of this system must design the air distribution system for their particular application. Several requirements must be met for the unit to operate properly. These requirements are as follows:

1. **NOTICE** Make sure ductwork will **NOT** bend or collapse during and after installation, and that it is correctly insulated and sealed. Otherwise, damage to roof structure and ceiling could occur.
2. All discharge air ducts must be properly insulated to prevent condensation from forming on their surfaces or adjacent surfaces during operation of unit. This insulation must be R-7 minimum. See (FIG. 3).
3. Ducts and their joints must be sealed to prevent condensation from forming on adjacent surfaces during operation of the unit.
4. Return air openings must have 40 square inches minimum free area including the filter.
5. Return air to the unit must be filtered to prevent dirt accumulation on unit cooling surface.

6. Air Distribution Installation

- a. Dometic Corporation recommends the basic configurations shown in (FIG. 4), (FIG. 5), (FIG. 6), & (FIG. 7). We have found by testing, that these configurations work best in most applications. It is the responsibility of the installer to review each RV floor plan to determine the following:

- Duct size
- Duct layout
- Register size
- Register location
- Thermostat location
- Indoor Temperature Sensor Location

These items must be determined in conjunction with the Air Distribution Duct System Sizing & Design requirements. See "C. Table - Air Distribution Duct Sizing & Design" on page (4).

 Installer responsible for any necessary adapters between unit and ductwork.

INSTALLATION INSTRUCTIONS

FIG. 4

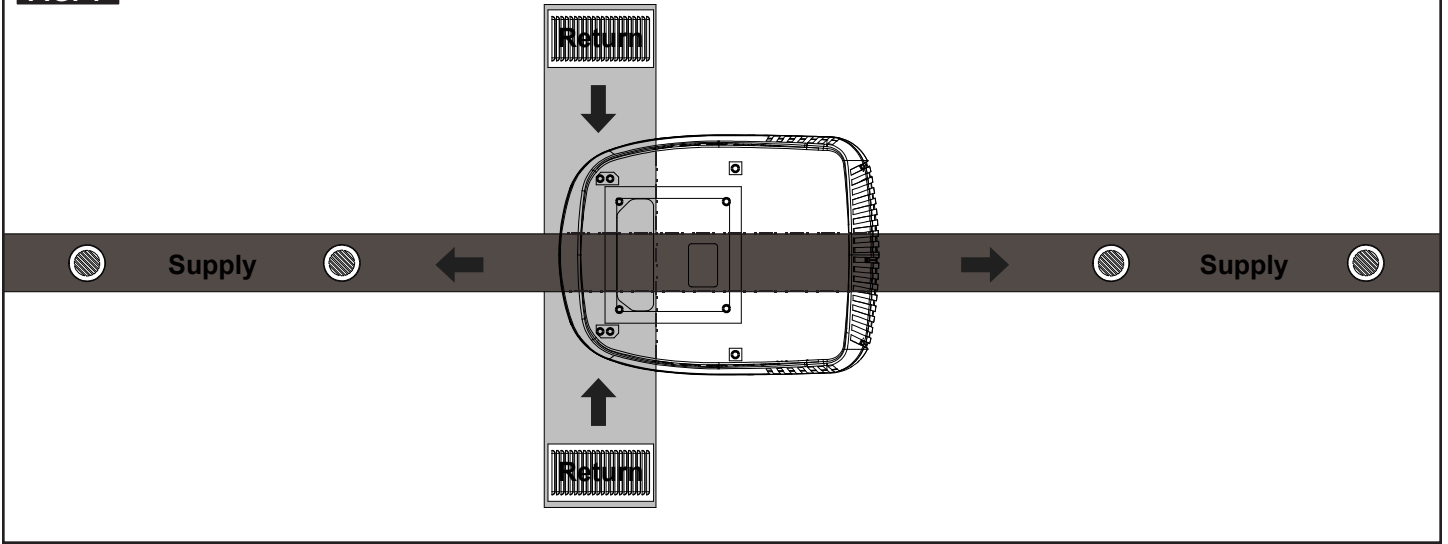

FIG. 5

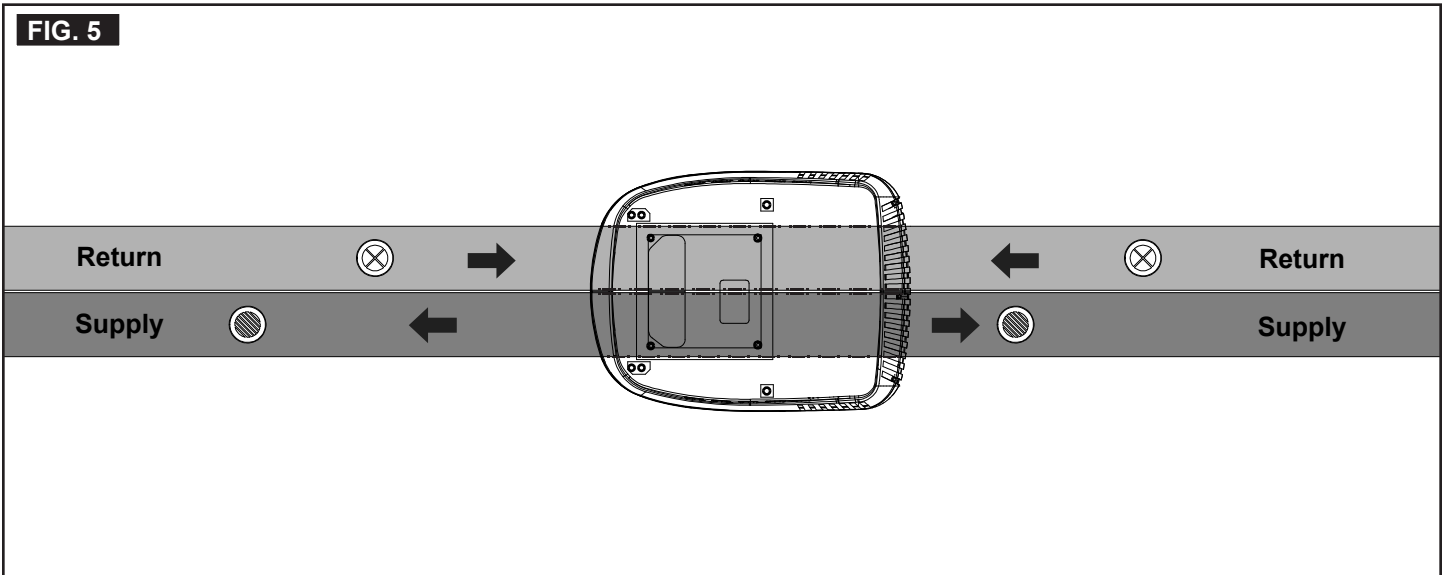
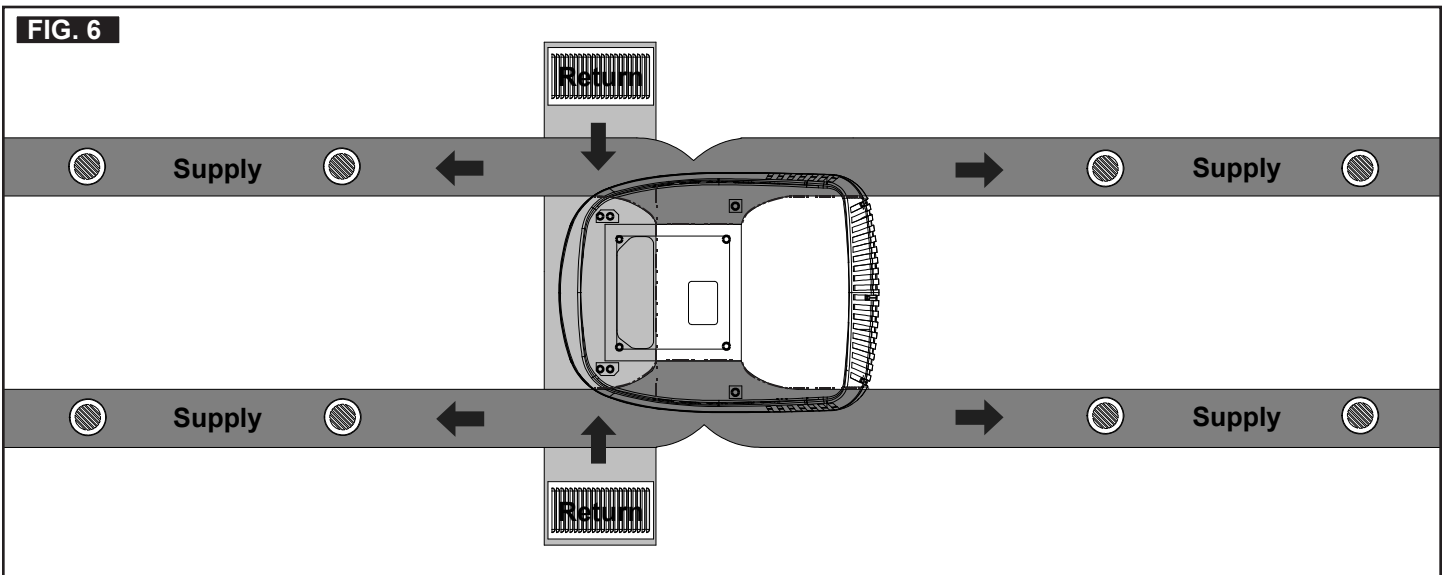
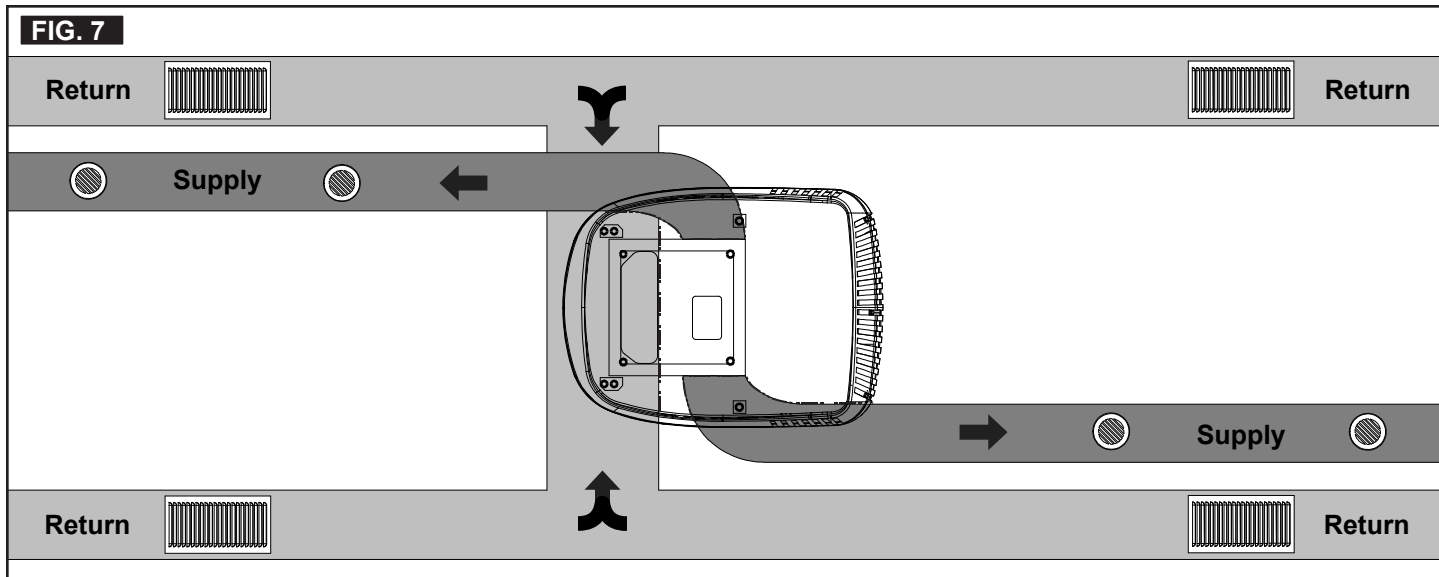

FIG. 6





INSTALLATION INSTRUCTIONS

FIG. 7



D. Wiring Requirements

1. Route a copper, with ground, 120 Vac supply wire from the time delay fuse or circuit breaker box to the roof opening. Use a listed/certified non metallic - sheathed single strand cable. See "A. Table - Unit Data" on page (4).
 - a. This supply wire must be located in the front portion of the roof opening.
 - b. The power **MUST** be on an appropriately sized separate time delay fuse or circuit breaker. See "A. Table - Unit Data" on page (4).
 - c. Make sure that at least 15" of supply wire extends into the roof opening. This ensures an easy connection at the junction box.
 - d. Protect the wire where it passes into the opening with approved method.
2. Route a dedicated 12 Vdc supply wire (18-22 AWG) from the RV converter (filtered side) or battery to the roof opening.
 -  When a Comfort Control Center 2 (hereinafter referred to as CCC 2) thermostat is being installed with more than 2 zones, route a dedicated 12 Vdc supply wire (18-22 AWG) to zone 1 and zone 3 roof opening.
 - a. This supply wire must be located in the front portion of the roof opening.
 - b. Make sure that at least 15" of supply wire extends into the roof opening.
3. Thermostat Communication Cable
 - a. CCC 2 Thermostat
 1. Route a 4 conductor communication cable from the roof opening to the thermostat mounting location using the shortest most direct route. Make sure that at least 15" of the wire extends into the roof opening and 6" extends from the wall at the thermostat mounting location. See "E. Choosing Thermostat Location" on page (9).
 -  When more than one unit is being installed (additional zones) with the CCC 2 thermostat, an additional 4 conductor communication cable **MUST** be routed to each additional unit roof opening. Make sure that at least 15" of the wire extends into the roof opening. See (FIG. 35).
 - b. LCD SZ Thermostat
 1. Route a 3 conductor communication cable, 18 to 22 AWG, from the roof opening to the Liquid Crystal Display Single Zone (hereinafter referred to a LCD SZ) thermostat mounting location. Make sure that at least 15" of the wire extends into the roof opening and 6" extends from the wall at the thermostat mounting location. See "E. Choosing Thermostat Location" on page (9).
4. (CCC 2 system only) Optional Indoor Temperature Sensor

INSTALLATION INSTRUCTIONS

- a. Route an indoor temperature sensor (optional) from the roof opening to the indoor temperature sensor location. The 2 pin connector end goes to the roof opening. See indoor temperature sensor installation instructions for proper sensor location.
5. If system includes a gas furnace, route two 18 gauge thermostat wires from the furnace to the roof opening of the unit that will control it. If more than one furnace is to be used, route the second set of thermostat wires to the second unit. Make sure that at least 15" of wire extends into the opening.
6. (CCC 2 system only) If an Energy Management System (load shed feature) is to be used with the control, two wires must be routed to the roof opening of the zone to be managed. The signal required for this function is normally an open relay contact. When the EMS calls for the compressor to shut off, the relay contacts should close. Make sure that at least 15" of the EMS wire extends into the roof opening.
7. (CCC 2 system only) If an Automatic Generator Start (AGS) kit will be installed, an additional 4 conductor communication cable must be routed from the last unit to the location of the AGS kit. Follow AGS kit instructions for installation.

E. Choosing Thermostat Location

1. CCC 2 system without an optional indoor temperature sensor and LCD SZ system
 - a. The proper location of the thermostat is very important to ensure that it will provide a comfortable RV temperature. Observe the following rules when selecting a location.
 - Locate the thermostat 54" above the floor.
 - Install the thermostat on a partition, not on an outside wall.
 - **NEVER** expose the thermostat to direct heat from lamps, sun, or other heat producing items.
 - Avoid locations close to doors that lead outside, windows, or adjoining outside walls.
 - Avoid locations close to supply registers and the air from them.
2. CCC 2 system with an optional indoor temperature sensor in ALL zones
 - a. The thermostat may be mounted anywhere in the RV that is convenient. Try to avoid hard to reach and hard to see areas.
 1. Refer to the instructions provided with the indoor temperature sensor for details of installation.

F. Thermostat, Optional Indoor Temperature Sensor & Thermostat Communication Cable Installation

1. CCC 2 System
 - a. The previously run communication cable (4 conductor telephone cable) must be terminated with two (2) RJ-11-6C4P telephone connectors. Refer to the crimp tool manufacturer for crimping instructions. See (FIG. 8) & (FIG. 9).

 RJ-11-6C4P connectors **MUST** be installed as shown in (FIG. 8) & (FIG. 9).

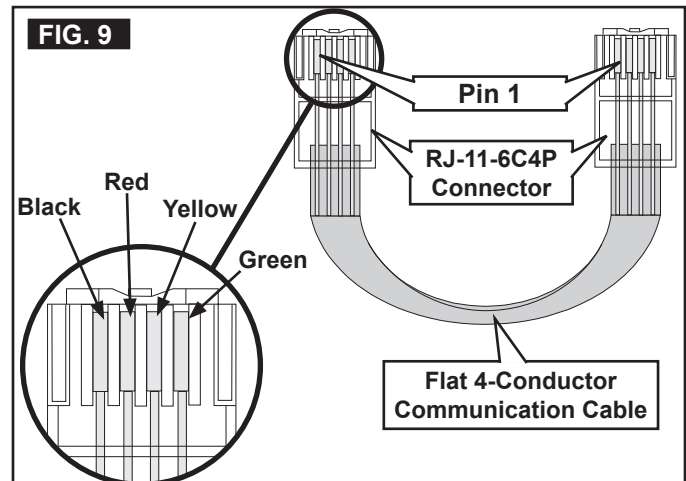
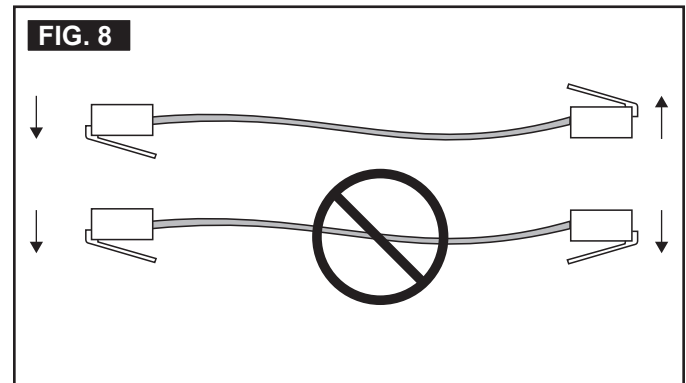

- b. Route the communication cable through the 2" diameter hole in the wall required for the thermostat. See (FIG. 10).
- c. Optional Indoor Temperature Sensor
 1. Refer to the instructions provided with the indoor temperature sensor for details of installation.

INSTALLATION INSTRUCTIONS

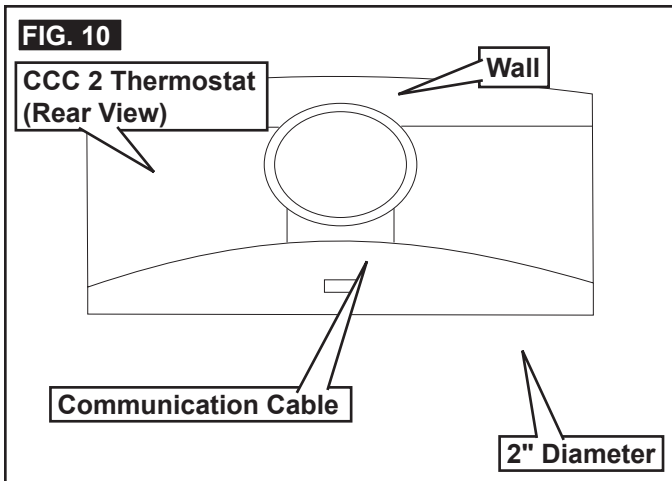

d. Thermostat Installation

- I. Carefully separate the thermostat base plate from the thermostat cover. Insert a small screw driver into the slot on bottom of thermostat and disengage the tab. See (FIG. 11).

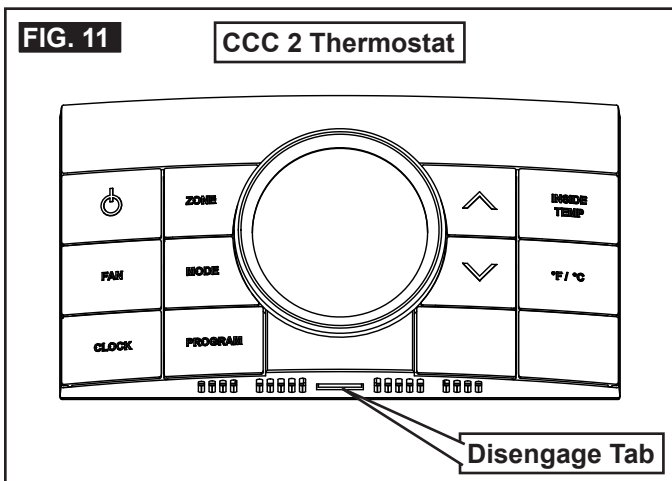

- II. Insert the 4 conductor communication cable through the hole in base plate. Align thermostat base plate with hole in wall. Make sure base plate is level and attach base plate to wall using the four (4) supplied screws.
- III. Insert the 4 conductor communication cable connector (RJ-11-6C4P) into the connector on the back of the thermostat. See (FIG. 12).
- IV. Align the thermostat with the back plate and snap into position.

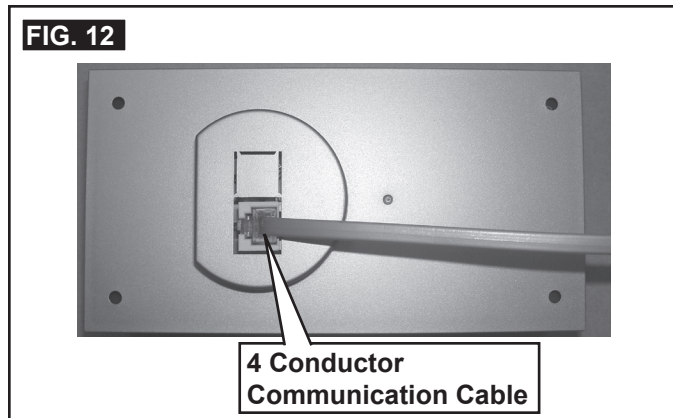

2. LCD SZ System

i Wire colors listed for the communication cable (3 conductor cable) match the wire colors in the unit wire harness and the wire harness at the LCD SZ electronic control box. Available wire colors may vary.

- a. Remove the cover from the LCD SZ thermostat. Depress tab on bottom of thermostat and separate it from the base.
- b. Insert the previously run communication cable (3 conductor cable) through the hole in the base assembly.
- c. Cut back the outer cable shield approximately 3 inches and strip 1/4" insulation from each wire.
- d. Mount the thermostat level on the wall using the screws provided.
- e. Make the following connections to the thermostat. See (FIG. 13).

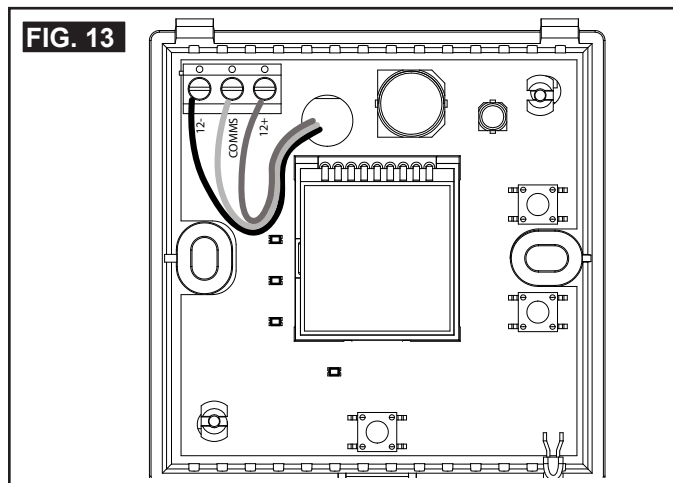

- Red/white wire to the 12V+ terminal
- Black wire to the 12V- terminal
- Orange wire to the "COMMS" terminal

INSTALLATION INSTRUCTIONS

- f. Inspect all connections to make sure they are tight and not touching any other terminals or wires.
- g. Push the wires back through the base into the wall. Place cover on the thermostat and push until an audible click is heard.

G. Placing Unit On Roof

1. Remove the unit from the carton and discard carton.
2. **CAUTION** LIFTING HAZARD. Use proper lifting technique and control when lifting product. Failure to obey this caution could result in injury.
3. Identify foam blocks and roof gasket as shown. Ensure they are properly located. See (FIG. 14).

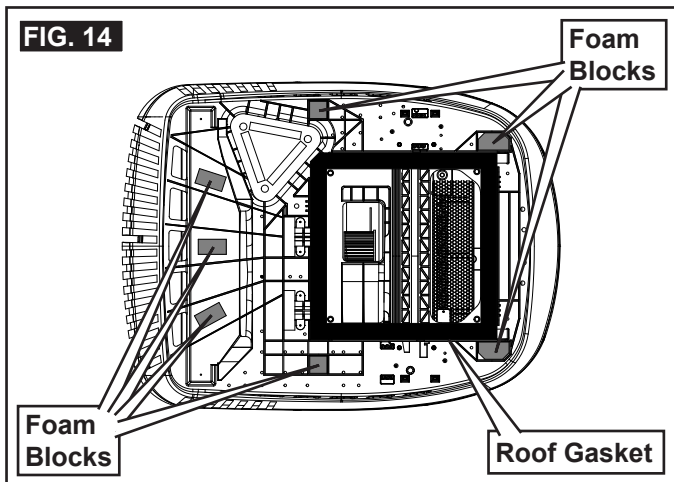

4. Place unit on roof.
5. **NOTICE** Do **NOT** slide unit. Otherwise, damage to gasket (on bottom of unit) may occur, and could cause a leak. See (FIG. 15).

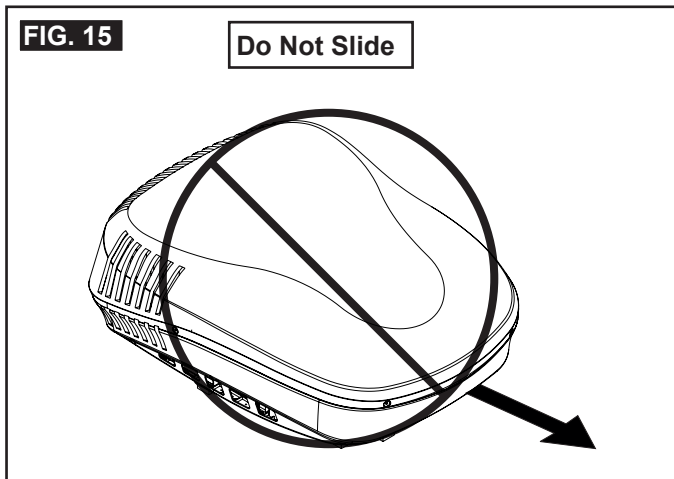

6. Position unit to the side of the roof opening to access wiring.

H. (CCC 2 System Only) Configuration

1. Electronic Control Configuration
Depending on the equipment options installed by the RV manufacturer, the appropriate dip switches will need to be switched to the "ON" position. Placing the switch in the "ON" position selects that option. See (FIG. 16), (FIG. 17), & (FIG. 18).

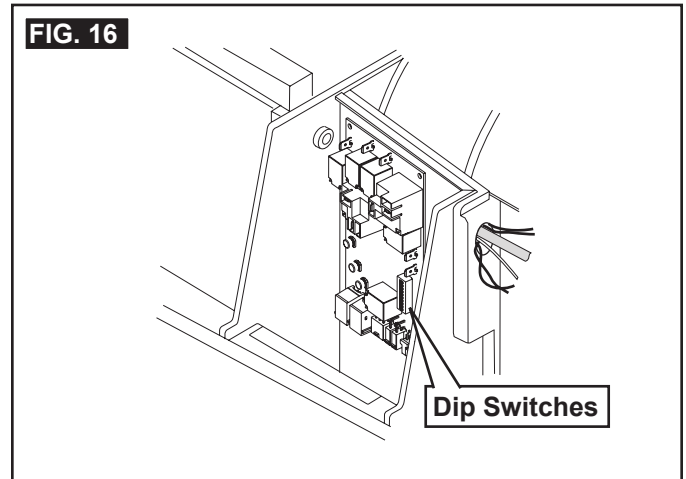

i Dip switches are in the "OFF" position when shipped from the factory except heat pump and factory installed heat strip models. On these models the appropriate dip switch, heat pump or heat strip, is in the "ON" position from the factory.

To gain access to the dip switches, the outside plastic shroud **MUST** be removed from the unit. Next remove the electrical box cover. The electrical box will be on the curb side of the RV after installation. See (FIG. 16).

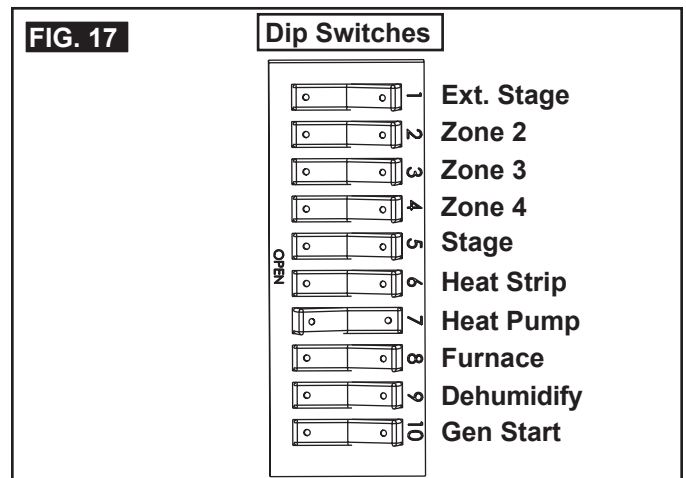

INSTALLATION INSTRUCTIONS

- a. Ext. Stage - Ext. Stage is not used on this unit. Leave in the "OFF" position.
- b. Zone selection - Each CCC 2 thermostat can have up to 4 zones. When only one unit is installed it becomes Zone 1 and no dip switch setting is required. Each additional unit must be assigned a zone (2 through 4). Each unit must have a different zone setting.
- c. Stage selection - Stage is not used on this unit. Leave in the "OFF" position.
- d. Heat Strip - On heat strip models the #6 dip switch is in the "ON" position from the factory. Non heat strip models leave in the "OFF" position.
- e. Heat Pump - On heat pump models the #7 dip switch is in the "ON" position from the factory. Non heat pump models leave in the "OFF" position.
- f. Furnace - If a Furnace/Aqua heat system has been connected to this unit, the furnace dip switch must be placed in the "ON" position.
- g. Dehumidify - Dehumidify is not used on this unit. Leave in the "OFF" position.
- h. Gen Start selection - Leave in the "OFF" position.
- i. Install unit electrical box cover and out side plastic shroud.
- j. Repeat this procedure for each additional zone.

2. **⚠ WARNING** ELECTRICAL SHOCK HAZARD. Provide grounding in compliance with all applicable electrical codes. Failure to obey this warning could result in death or serious injury.
3. Reach up into the return air opening of the unit and pull down the unit electrical cord and power supply wires. Note the included strain relief attached to the electrical cord. See (FIG. 19).

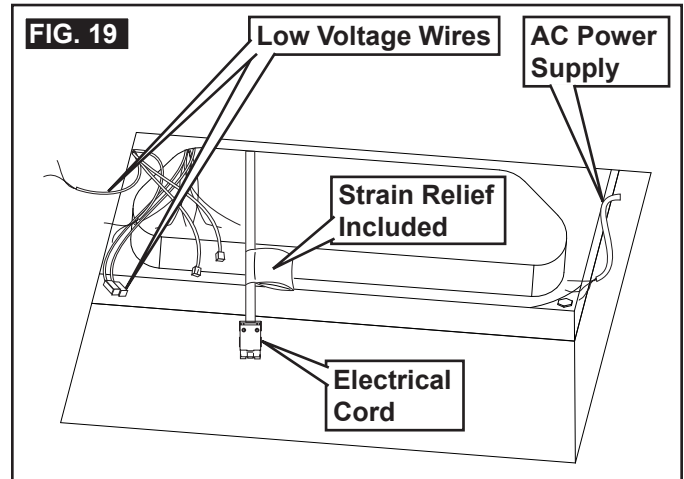

4. Remove the strain relief from its packaging and set aside momentarily.
5. Carefully strip and prepare 120 Vac supply wire. See (FIG. 20), (FIG. 21), (FIG. 22), (FIG. 23), & (FIG. 24).

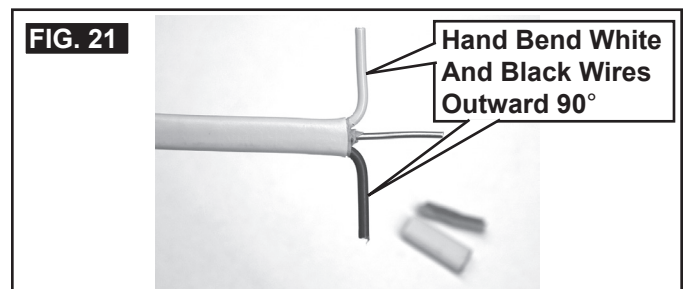
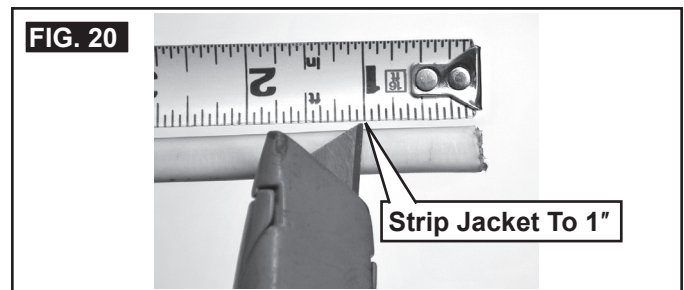
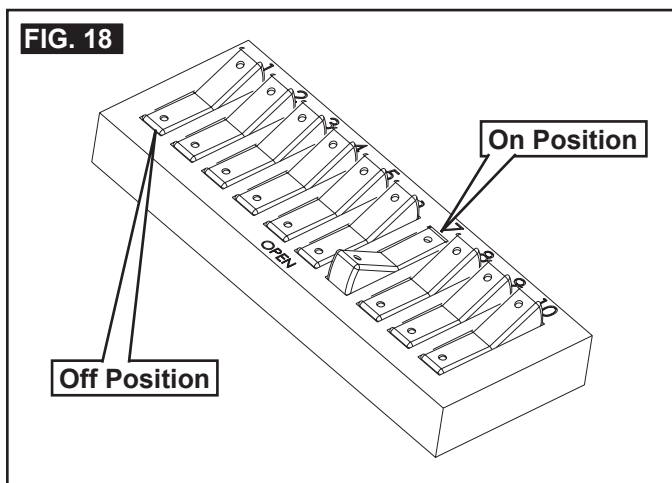

I. 120 Vac Power Supply Connection

1. **⚠ WARNING** ELECTRICAL SHOCK HAZARD. Make sure 120 Vac power is disconnected from RV. Failure to obey this warning could result in death or serious injury.

INSTALLATION INSTRUCTIONS

FIG. 22

Use Tip Of Pliers To Hold Wire In Place While Hand Bending Wire At 90°

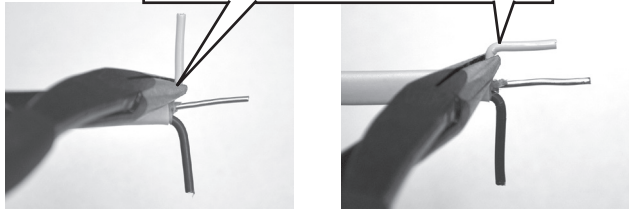

FIG. 23

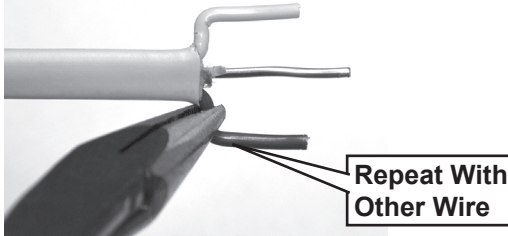
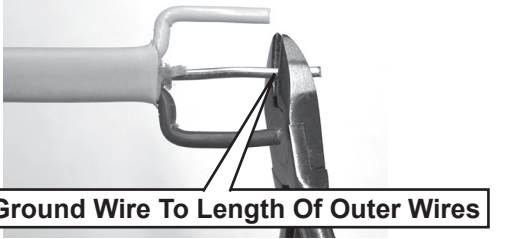

FIG. 24



6. Hold the clear strain relief cover with the bottom facing upward. See (FIG. 25).

FIG. 25

Load Cable into Strain Relief

Roll Cable Sheath Into Integral Strain Relief

Wire Locator Slots

Strain Relief Fingers

Strain Relief Cover (Bottom Facing Upward)

Position Black Wire Into Locator Slot

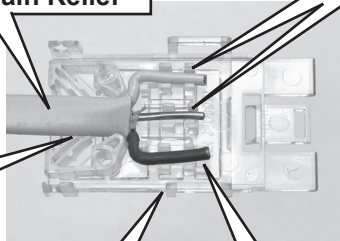

7. Lay wire into locator slots, making sure the black wire is placed into the polarization slot. See (FIG. 25).

8. Press the cable sheath into the integral strain relief slot. See (FIG. 25). Trimming of ground wire and possibly others will be necessary. Wires must not extend beyond the locators. See (FIG. 26).

FIG. 26

Housing Assembly

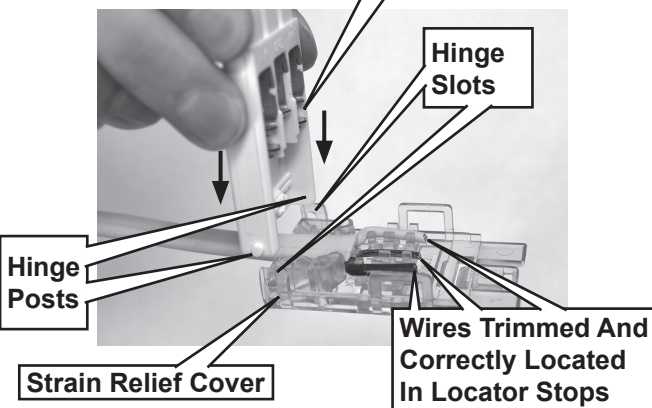

9. While holding the strain relief cover, position the housing's hinge posts into the hinge slots and press down until both lock into place. See (FIG. 26).

10. Close the strain relief cover and housing by hand. Squeeze the top and bottom closed with tongue and groove pliers. See (FIG. 27). Pliers must be a minimum of 10" long. Squeeze firmly on both sides, squarely across the connector between ribs A and B to ensure wires seat completely into slots.

FIG. 27

Attaching Housing Assembly To Strain Relief Cover With Tongue And Groove Pliers, Squeeze Squarely & firmly Between Ribs A & B

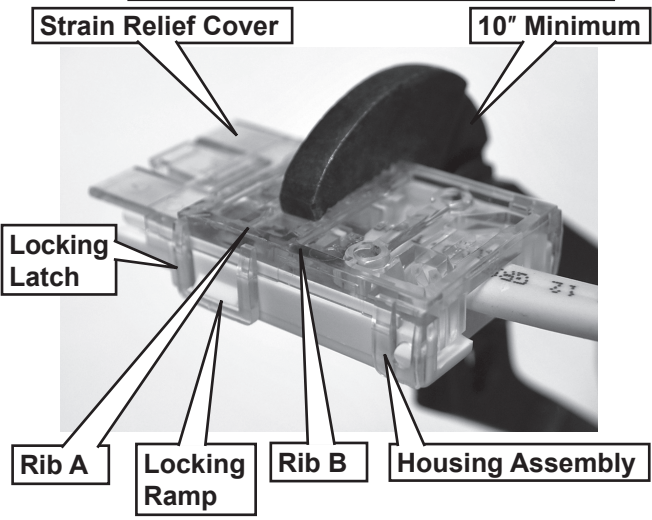

INSTALLATION INSTRUCTIONS

11. Inspect the connector to ensure the wires have been properly engaged into the housing assembly contacts. A properly terminated wire is fully seated into its proper slots with no significant bow of the cover. If the wires extend past the insulation stops the wires must be re-terminated with a NEW CONNECTOR. Once the cover has been closed the connector cannot be re-used. Failure to comply with this procedure may result in the failure of the connector.
12. Mating and un-mating the completed connector is illustrated below. See (FIG. 28).

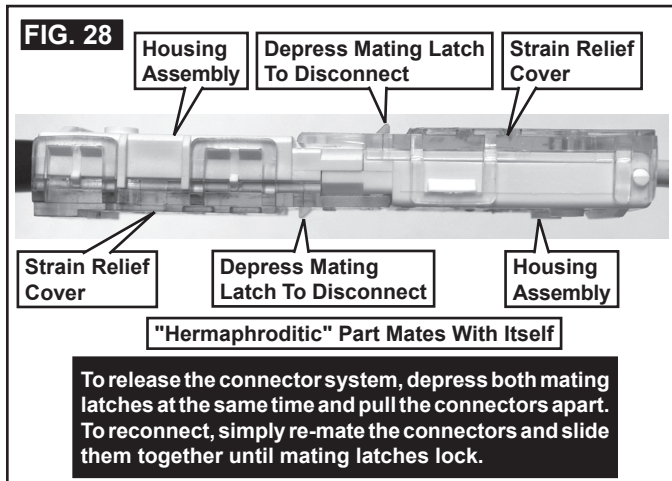

J. LCD SZ System Low Voltage Wire Connections

NOTICE Make sure the positive (+) 12 Vdc terminal is disconnected from supply battery. Otherwise, damage to unit could occur.

1. Connect the previously run +12 Vdc supply wire to the red wire protruding from the roof opening.
2. Connect the previously run -12 Vdc supply wire to both the black wire protruding from the roof opening and to the wire of the three wire cable that goes to the thermostat 12V- terminal.
3. Connect the previously run furnace thermostat wires (if applicable) to the blue wires protruding from the roof opening using the supplied 1/4" insulated connectors. The polarity of this connection does not matter.
4. Connect the red/white wire protruding from the roof opening to the wire of the three wire cable that goes to the thermostat 12V+ terminal.
5. Connect the orange wire protruding from the roof opening to the wire of the three wire cable that goes to the thermostat COMMS terminal.

K. CCC 2 System Low Voltage Wire Connections

NOTICE Make sure the positive (+) 12 Vdc terminal is disconnected from supply battery. Otherwise, damage to unit could occur.

1. Connect the previously run 12 Vdc supply wires to the red and black wires protruding from the roof opening. Connect +12 Vdc to the red wire; -12 Vdc to the black wire.
2. Connect the previously run furnace thermostat wires (if applicable) to the blue wires protruding from the roof opening. The polarity of this connection does not matter.
3. Terminate the 4 conductor communication cable(s) protruding from the roof opening. The cable(s) must be terminated with a telephone RJ-11-6C4P connector. Refer to the crimp tool manufacturer for crimping instructions.
 RJ-11-6C4P connectors **MUST** be installed as shown in (FIG. 8) & (FIG. 9).
4. Plug the 4 conductor communication cable into one of the couplers protruding from the roof opening. If more than one zone is used, the second coupler is used to join each additional zone.
5. Plug the indoor temperature sensor cable (if applicable) into the 2 pin matching connector protruding from the roof opening.
6. Connect the previously run Energy Management System wires (if applicable) to the yellow wires protruding from the roof opening. The polarity of this connection does not matter.
7. If an automatic generator start (AGS) kit is installed, follow installation instructions furnished with AGS kit.

L. Securing Unit To Roof

CAUTION LIFTING HAZARD. Use proper lifting technique and control when lifting product. Failure to obey this caution could result in injury.

NOTICE Do **NOT** slide unit. Otherwise, damage to gasket (on bottom of unit) may occur, and could cause a leak.

1. Lift and place the unit over the prepared opening using the gasket on the unit as a guide. See (FIG. 29).

INSTALLATION INSTRUCTIONS

FIG. 29

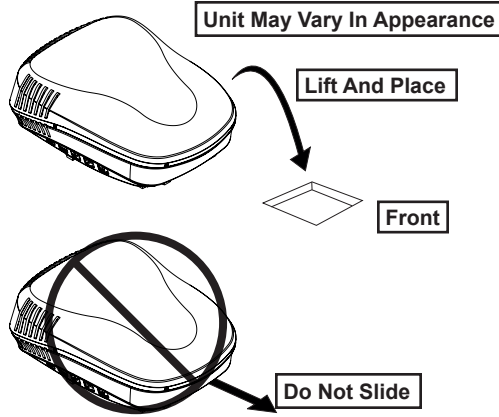

Model
H540315
H540316
Shown

2. Remove shroud.
3. Align four (4) Dometic cubes with base pan as shown. See (FIG. 30).

i Dometic cubes ensure proper foam block compression of approximately 1-1/6".

FIG. 32

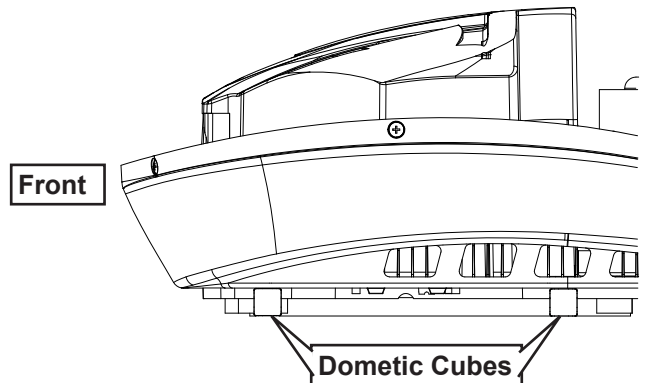

5. Locate mounting holes in base pan.
6. Pre-drill the mounting holes in roof with 15/64" bit with a drill gun using a depth gauge.

i Do **NOT** drill without depth gauge to ensure bit does **NOT** penetrate cold air duct.

7. Match 3" lag with bonded sealing washer.
8. Drive screw using 9/16" socket. Finish installation with socket until base pan is lightly seated on Dometic cubes. See (FIG. 30).

NOTICE Tighten mounting bolts to achieve proper foam block compression. Overtightening could damage unit's base pan. Under tightening will allow an inadequate roof seal, and could cause a leak.

i Proper compression is achieved when foam blocks compress to approximately 1-1/6" so that Dometic cubes no longer move freely beneath the base pan. There should be slight resistance between Dometic cubes and base pan upon attempted removal of cubes.

FIG. 30

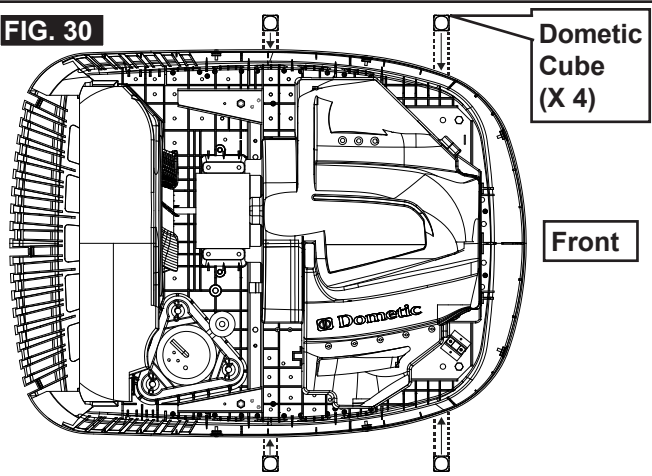

4. Maintaining alignment, place Dometic cubes beneath edge of base pan. See (FIG. 30), (FIG. 31) & (FIG. 32).

FIG. 31

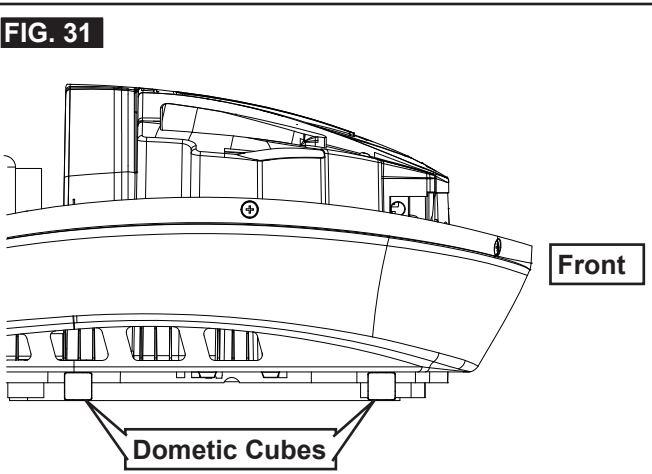
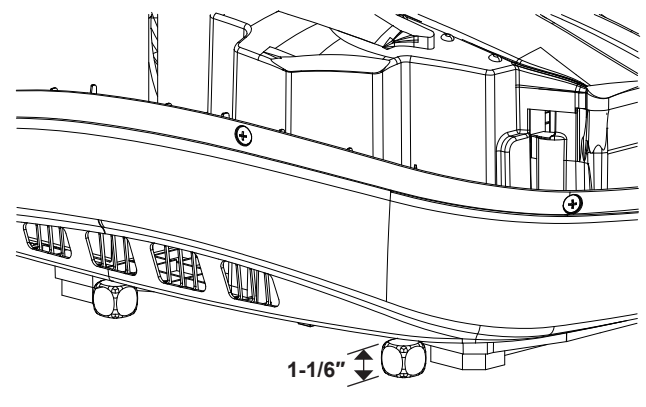



FIG. 33

Dimensions Are Nominal



INSTALLATION INSTRUCTIONS

9. Remove Dometic cubes.

 Save Dometic cubes for future unit installations.

10. Reinstall shroud.

M. (LCD SZ System Only) System Checkout

1. Verify that all features of the system work. See the LCD SZ thermostat Operating Instructions or User's Guide. Reconnect the 12 Vdc and 120 Vac power supplies. Check fan speeds, cooling mode, heating mode, and furnace mode (if connected) operation.

If features do not work, disconnect the 120 Vac and 12 Vdc power supplies and verify that all wiring is correct.

N. (CCC 2 System Only) Reset & Checkout

1. System Reset

After setting the dip switches in the electronic control, do a system reset.

- a. Re-connect the 12 Vdc and 120 Vac power supplies.
- b. Make sure the CCC 2 thermostat is in the **OFF** mode.
- c. Simultaneously press the **MODE** and **ZONE** buttons. The LCD will display "IniT" and all available zones.
- d. Release the **MODE** and **ZONE** buttons.
- e. Press the **ON/OFF** button to exit system set up.
- f. When a dip switch is turned on after initial configuration, a system reset will need to be done before the CCC 2 thermostat will recognize the updated selection.

2. System Checkout

- a. Verify that all features of the installed system work. See CCC 2 thermostat Operating Instructions or User's Guide. Check the fan mode, cooling mode, heating mode (if applicable), and furnace mode (if applicable) operation. If features do not work, disconnect the 120 Vac and 12 Vdc power supplies and verify that all wiring is correct and that the correct dip switches have been set to the **"ON"** position.

O. (CCC 2 System Only) Furnace/Aqua Temperature Differential Setting

This system can be configured to operate using an ON/OFF differential of either 1 degree F or 2 degree F. See (FIG. 34).

1. To set the differential, simultaneously press the **PROGRAM** button and the **^** up button on the CCC 2 thermostat. "diF1" will appear in the display while the buttons are pressed. See (FIG. 34). To set the 2 degree differential, simultaneously press the **PROGRAM** button and the **∨** down button "diF2" will appear in the display while the buttons are pressed.

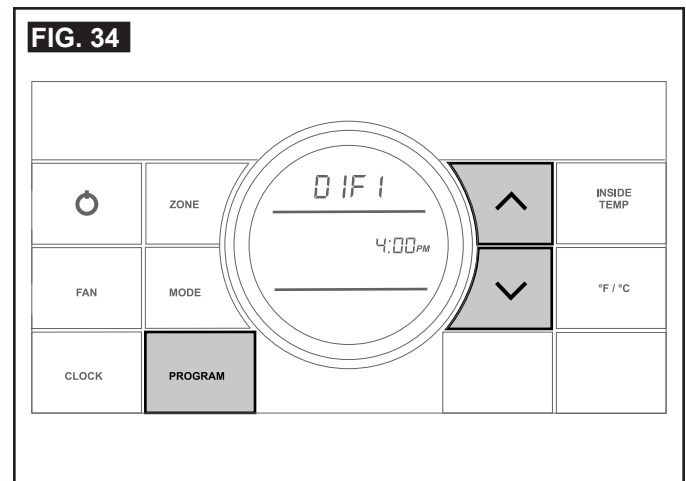

GENERAL INFORMATION

A. Heat Gain

The ability of this air conditioner to maintain the desired inside temperature depends on the heat gain of the RV.

Some preventative measures taken by the occupants of the RV can reduce the heat gain and improve the performance of the air conditioner. During extremely high outdoor temperatures, the heat gain of the RV may be reduced by:

1. Parking the RV in a shaded area
2. Using window shades (blinds and/or curtains)
3. Keeping windows and doors shut or minimizing usage
4. Avoiding the use of heat producing appliances

Operation on High Fan/Cooling mode will give optimum or maximum efficiency in high humidity or high outside temperatures.

Starting the air conditioner early in the morning and giving it a "head start" on the expected high outdoor ambient will greatly improve its ability to maintain the desired indoor temperature.

For a more permanent solution to high heat gain, accessories like Dometic outdoor patio and window awnings will reduce heat gain by removing the direct sun. They also add a nice area to enjoy company during the cool of the evening.

B. Condensation

The manufacturer of this unit will not be responsible for damage caused by condensation forming on ceilings, windows, or other surfaces. Air contains water vapor which condenses when temperature of a surface is below Dew point. During normal operation this unit is designed to remove a certain amount of moisture from the air, depending on the size of the space being conditioned. Keeping doors and windows closed when this air conditioner is in operation will greatly reduce the chance of condensation forming on interior surfaces.

WIRING DIAGRAMS

A. Simple RV Wiring Diagram

FIG. 35

