

RM3762 RM3962**FOR YOUR SAFETY**

If you smell gas:

1. Open windows.
2. Don't touch electrical switches.
3. Extinguish any open flame.
4. Immediately call your gas supplier.

FOR YOUR SAFETY

Do not store or use gasoline or other flammable vapors and liquids in the vicinity of this or any other appliance.

⚠ WARNING

Improper installation, adjustment, alteration, service or maintenance can cause injury or property damage. Refer to this manual. For assistance or additional information consult a qualified installer, service agency or the gas supplier.

⚠ WARNING

If the refrigerator stops cooling - or - if it emits an ammonia smell, immediately turn the refrigerator off and contact a Service Center.

REVISION B

Form No. 3313513.016 09/16
(French 3313514.014_B)
©2016 Dometic Corporation
LaGrange, IN 46761

USA

Dometic Corporation
Service Office
1120 North Main Street
Elkhart, IN 46514

CANADA

Dometic Corporation
46 Zatonski, Unit 3
Brantford, ON N3T 5L8
CANADA

**For Service Center &
Dealer Locations**

Please Visit:
www.eDometic.com

INTRODUCTION

Thank you for purchasing a new Dometic refrigerator. This product is a recreational vehicle refrigerator intended for the storage of fresh and frozen foods, as well as making ice.

Appearance of your product may vary from illustrations shown in this document.

Please read and be aware of possible safety hazards identified in this manual, and become familiar with the alert symbols on the refrigerator. Read this manual carefully so that you know how to operate the refrigerator safely and correctly. Keep this manual with the refrigerator for future reference.

CONTENTS

REFRIGERATOR OVERVIEW	4
INSTRUCTIONS FOR USE.....	6
STORAGE COMPARTMENTS	9
PRODUCT CARE	10
MAINTENANCE & SERVICE	12
TROUBLESHOOTING	14
APPENDIX A - SPARE PARTS	16
APPENDIX B - REARVIEW EQUIPMENT	17
APPENDIX C - WIRING DIAGRAM	18
APPENDIX D - CONSUMER SUPPORT	19
APPENDIX E - DOMETIC WARRANTY	20
APPENDIX F - MAINTENANCE SCHEDULE.....	21
REGISTRATION CARD.....	23

SYMBOLS

The following symbols are used throughout this manual:



This is the safety alert symbol. It is used to alert you to personal injury hazards. Obey all safety messages that follow this symbol to avoid possible injury or death.



WARNING indicates a hazardous situation which, if not avoided, could result in death or serious injury.



CAUTION, used with the safety alert symbol, indicates a hazardous situation which, if not avoided, could result in minor or moderate injury.



NOTICE is used to address practices not related to personal injury.



Information



Step-by-step instructions

REFRIGERATOR OVERVIEW

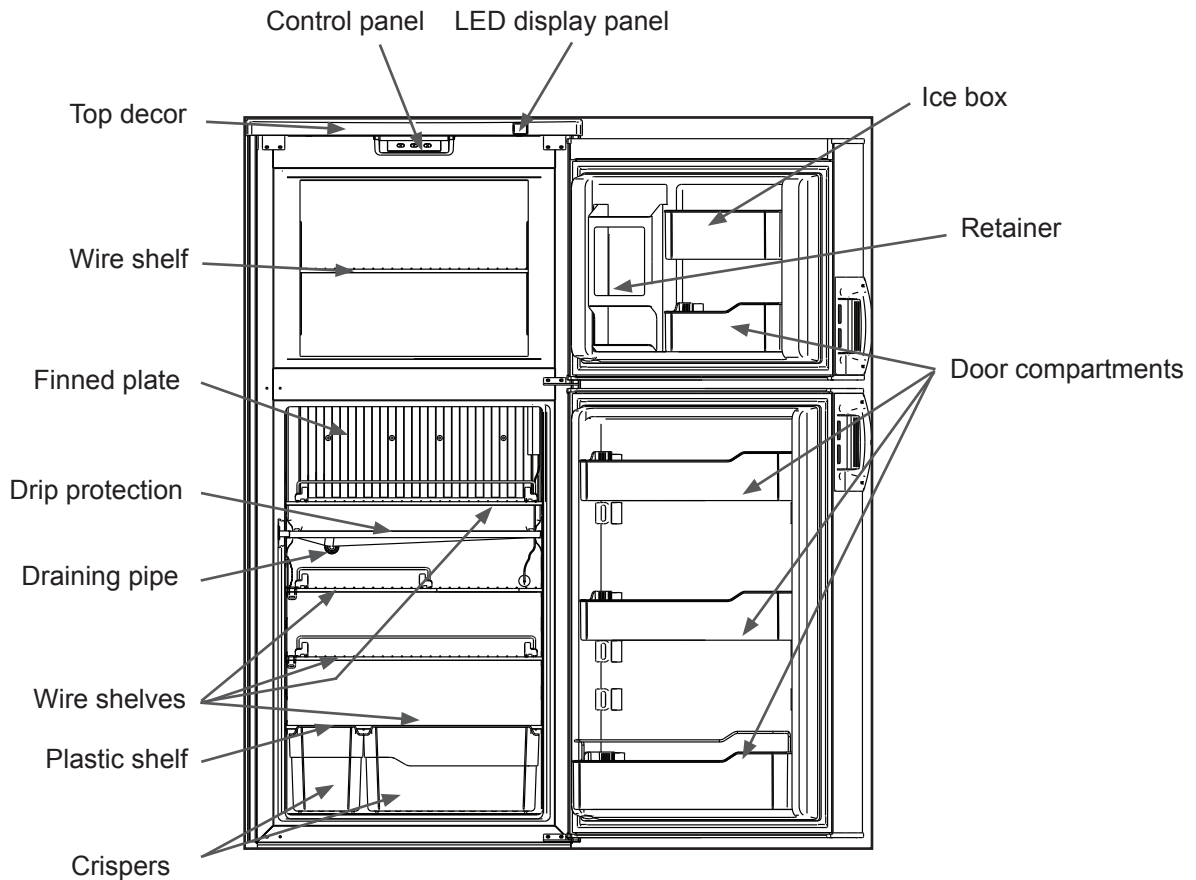

Appearance and features may vary depending on model. Quantity and position of items may also vary.

CONTROL PANEL

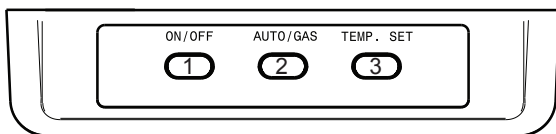

1. ON/OFF button (main power)

Press this button to turn the refrigerator ON or OFF.
Button In = Unit Is ON Button Out = Unit Is OFF

2. AUTO/GAS mode selector button

Press this button to turn the AUTO mode ON or OFF.
Button In = Auto Mode (Attempts Electric Mode First)
Button Out = Auto OFF (Attempts LP Gas Mode Only)

3. TEMP. SET button

The thermostat has 5 settings where "1" indicates the warmest and "5" the coldest temperature setting. Press this button once to display the current setting. Continue to press repeatedly until the desired setting, e.g. "3", is shown in the LED display. This value is shown for about 5 seconds and then the fresh food compartment temperature is displayed once again.

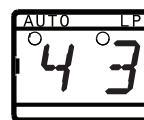

LED DISPLAY PANEL



The LED display panel provides a quick visual indicator of the temperature in the fresh food storage compartment, modes of operation, status messages, and alarm conditions. See LED PANEL INDICATIONS table on the following page.

REFRIGERATOR OVERVIEW

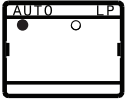
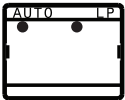
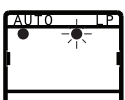
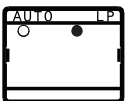
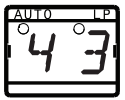
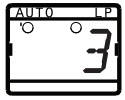
LED PANEL INDICATIONS

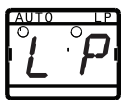
LED PANEL INDICATIONS	STATUS INFORMATION
Display is on	Refrigerator on
Display is off	Refrigerator off
The AUTO indication dot is lit.	 AUTO mode and AC operation
The AUTO and LP indication dots are lit.	 AUTO mode and LP gas operation
The AUTO indication dot is lit. LP indication dot flashes slowly.	 Temporary gas lockout function. Only in AUTO mode. It delays LP gas operation by 15 minutes when ignition switch is turned OFF. This is for stopping at a refueling station.
The LP indication dot is lit.	 Manual LP gas operation mode.
Digital display:	
	Fresh food storage compartment temperature.
	Thermostat range setting indication (1 - 5). Temporary during setting. The thermostat settings are stored automatically after 5 sec. of inactivity.
Message indications:	
"60" is displayed.	 Fresh food compartment temperature is above measurement range.
"LP" is flashing (The message alternates between "LP" and the fresh food compartment temperature.)	 LP gas operation lock out. (Check LP gas.)

ABSORPTION COOLING SYSTEM



When turning on the refrigerator, you should adjust the thermostat to the coldest temperature setting. The cooling cycle may require an extended running time before cooling effect is observed.

LEVELING THE REFRIGERATOR

Leveling is one of the requirements for proper operation with absorption refrigerators. To ensure proper leveling the vehicle needs to be leveled so it is comfortable to live in (no noticeable sloping of floor or walls).

Any time the vehicle is parked for several hours with the refrigerator operating, the vehicle should be leveled to allow proper cooling.

When the vehicle is moving, the leveling is not critical, as the rolling and pitching movement of the vehicle will pass to either side of level, keeping the liquid ammonia from accumulating in the evaporator tubing.

OPERATING REFRIGERATOR AT HIGH ALTITUDE

All gas appliances experience lowered efficiency (or rating) at high altitude. This is a direct result of lower atmospheric pressure and oxygen levels, and is not a defect of the refrigerator.

Reduced cooling performance and burner outage may occur at altitudes higher than 5500 feet above sea level (while operating on LP gas). Always operate refrigerator on electric power at altitudes higher than 5500 feet.

AUTOMATIC ENERGY SELECTOR CONTROL SYSTEM

The refrigerator is equipped with an automatic energy selector control system. The user turns the refrigerator on, selects the desired temperature, and then the refrigerator automatically selects the most suitable energy source available (either 120 VAC or LP gas operation). The system can be set by the user to be fully automatic (AUTO mode is selected) or to operate on LP gas only (AUTO mode is off).

The refrigerator controls will work down to 9.6 volt DC.

PURGING AIR FROM THE LINES

If the refrigerator has not been used for a long time - or - the LP tanks have just been refilled, air may be trapped in the supply lines. To purge the air from the lines, turn the refrigerator off and on by pressing the ON/OFF button. If the flame is not lit within 45 seconds, turn the refrigerator off and back on again. This procedure can be repeated 3 to 4 times. If repeated attempts fail to start the LP gas operation, check to make sure that the LP gas supply tanks are not empty and that all manual shutoff valves in the lines are open. If the problem persists, turn the refrigerator off and take it to a Service Center.

REFRIGERATOR OVERVIEW

MODES OF OPERATION

The refrigerator is equipped with a control system where the user can choose to turn the AUTO mode on or off.

AUTO MODE IS TURNED ON

The system is fully automatic which means that it selects the most suitable energy source available, either 120 VAC or LP gas operation.

TEMPORARY GAS LOCKOUT

When the refrigerator's temporary gas lockout is energized, the LP gas operation will automatically lock out for 15 minutes when the engine is switched off. This will prevent LP gas operation e.g. when stopping at a refueling station. See Installation Instructions ALTERNATOR (D+) CONNECTION to install this feature.

AUTO MODE IS TURNED OFF (GAS MODE)

The system operates on LP gas only. The control system activates the ignition system and makes one attempt to light the burner.

⚠ WARNING

FIRE OR EXPLOSION HAZARD. The temporary gas lockout feature will not work when AUTO mode is turned OFF. Consequently, while refueling or parking near a gasoline pump, make sure that AUTO mode is ON and all LP gas appliances vented to the outside of the vehicle are shut OFF. Otherwise, gasoline fumes from gasoline pumps could come into contact with an LP gas appliance burner flame and ignite. Failure to obey this warning could cause a fire or explosion resulting in death or serious injury.

INSTRUCTIONS FOR USE

STARTING THE REFRIGERATOR

⚠ WARNING

FIRE HAZARD. When the RV has not been used for some time, make sure that the path between the burner jet and the burner tube has not been obstructed before lighting the LP gas burner. Failure to obey this warning could cause a fire resulting in death or serious injury.

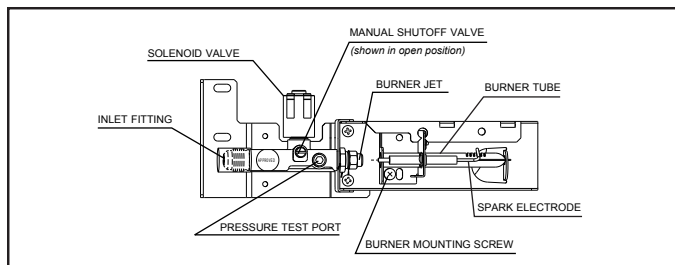

1. Check that all the manual gas valves are in the ON position.
2. Make sure that a continuous 12 VDC supply is available for the electronic control to function.
3. Press the ON/OFF button.

4. Select operation mode:

- AUTO mode (AC and LP gas)

Press the AUTO/GAS mode selector button (if not already on).

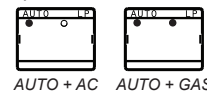

- GAS mode (LP gas operation only)

Press the AUTO/GAS mode selector button to turn off the AUTO mode (if not already off).



ADJUSTING THE THERMOSTAT

The adjustable thermostat ranges from 1 - 5 (5 = coldest temperature setting).

i After the initial start-up, adjust the thermostat by pressing the TEMP. SET button repeatedly until the desired setting is displayed.

The thermostat controls both the gas and electric operation. Thus, it is not necessary to reset each time a different energy source is employed.

OPERATING THE ICE MAKER (ICE MAKER MODELS ONLY)

Before the ice maker can operate, make sure that:

- The refrigerator is connected to 120 VAC.
 - The water valve supplying the refrigerator is turned on.
 - The ice level bail arm is in its fully down position.
- i** Keep bail arm in the up (OFF) position until water is present at the ice maker.

INSTRUCTIONS FOR USE

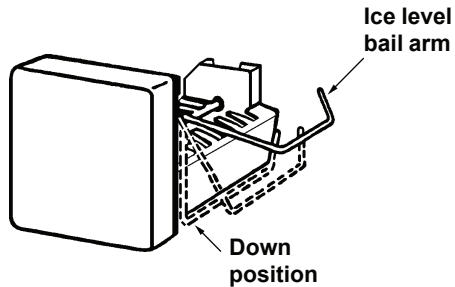

When the ice maker thermostat senses the preset temperature for the ejection of the ice cubes, the fingers will start to rotate, dumping any ice cubes and filling the mold with water. When the storage container is full, the bail arm will come in contact with the ice cubes. The bail arm cannot return to the full down position and the ice production is stopped until the bin is emptied, or ice cubes are removed. To prevent water from splashing out of the mold assembly while travelling in your recreational vehicle, raise the bail arm to the full UP/OFF position about 1-1/2 hours before departing. This will allow the water in the mold to freeze.

WATER SUPPLY

The water supply system must have a minimum pressure of 15 pounds per square inch gauge (psig). A 1/4" diameter water line to the water valve should be used at the rear of the refrigerator. The water line must have a manual shutoff valve placed where it is easily accessible.

The maximum water level is represented by a thin line. It is essential that the water level does not exceed this line!

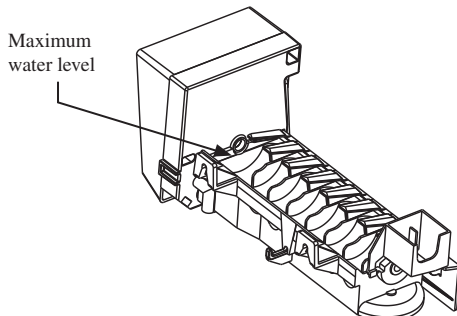

If necessary, change the water flow by adjusting the water supply. For instructions, see ADJUSTING THE SIZE OF CUBES.

ADJUSTING THE SIZE OF CUBES

i If the ice maker was cleaned and drained, no ice cubes will be dumped into the bin during the first cycle.

The first few cycles may have small cubes due to air trapped in the water lines. The first container of ice cubes should be dumped if the water system has been winterized or not used for several weeks. Once the ice maker has run through several cycles and if cubes are too small or sticking together, adjustment is necessary on the amount of water entering the mold.

TO ADJUST THE SIZE OF CUBES, FOLLOW THESE STEPS:

i 1. Remove the protective cover from the ice maker mechanism. Using a flat-head screwdriver, place the tip of the screwdriver in the slot. Twist the screwdriver blade gently to loosen the cover.

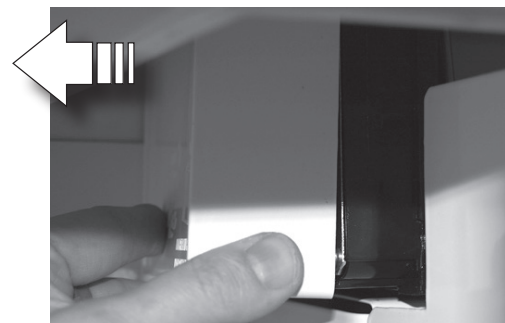
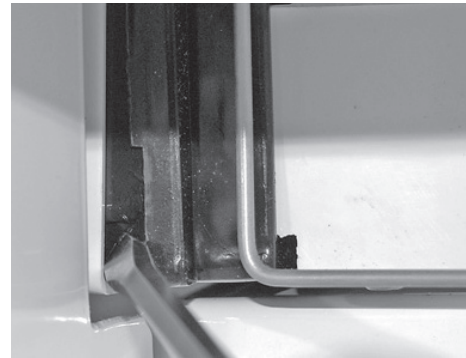

2. Locate the adjusting screw under the protective cover. Turn the screw counterclockwise to increase the size of cubes.

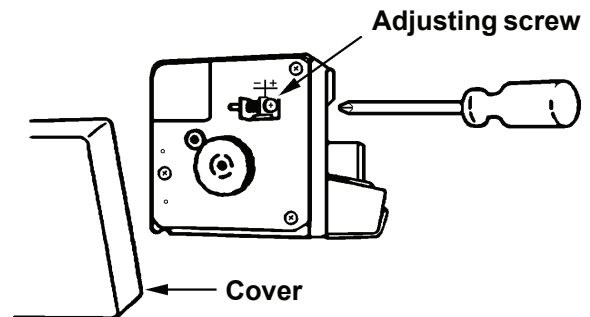

3. Turn the screw clockwise to decrease the cube size or if the mold is overfilling, and the cubes are stuck together.

i To prevent overfilling, do not turn the adjustment screw more than one revolution at a time. Allow the ice maker to cycle several times before another adjustment is made. Be sure to replace the protective cover on the cycle after the adjustments are complete.

INSTRUCTIONS FOR USE

COLD WEATHER LOW AMBIENT CONTROL

The refrigerator is equipped with an automatic Low Ambient Control (LAC) function which allows for trouble-free operation in low ambient temperature (below 50°F) for extended periods of time.

EXTREME COLD WEATHER OPERATION

Refrigerator performance may be reduced in extremely cold (subzero) temperatures. This temporary condition is normal for absorption refrigerators and does not indicate product failure. In the event that performance is reduced in such conditions, turn the refrigerator off. As ambient temperatures rise, please restart your refrigerator according to instructions before requesting service.

TURNING OFF THE REFRIGERATOR, AND WHEN IT IS NOT IN USE

You can turn off your refrigerator by pressing the main power ON/OFF button found on the control panel to the off position. This will shut off all power to the refrigerator, including DC power.

If the refrigerator will not be in operation for an extended period of time or put into winter storage, it should be emptied, defrosted, cleaned, and the doors placed in the airing position. If ice cube trays are in use, they should also be dried and kept outside the cabinet.

NOTICE

This refrigerator is intended for continuous use. Do not allow it to run unattended when there is a risk for loss of electricity or fuel. Food spoilage could occur.



The refrigerator's control system still consumes a few milliamps even if it is turned off. If your RV is being put into winter storage, it is recommended to either put your RV batteries on a battery charger or turn off the vehicle's main 12 VDC switch. This will prevent the RV battery from discharging.

STORAGE COMPARTMENTS

⚠ WARNING

FIRE OR EXPLOSION HAZARD. Do not store or use gasoline, oil or gasoline soaked rags, or other flammable vapors and liquids in the service area behind the refrigerator or in the vicinity of this or any other gas appliance. Failure to obey this warning could cause a fire or an explosion resulting in death or serious injury.

REFRIGERATOR VOLUME

REFRIGERATOR MODEL	TOTAL REFRIGERATED VOLUME (CU. FT.)
RM3762	7
RM3962	9

FOOD STORAGE COMPARTMENT

- Cool the refrigerator before placing any food inside. Never put hot food or drinks into the refrigerator - cool them first.
- The food storage compartment is completely closed and unventilated, which is necessary to maintain the required low temperature for food storage. Consequently, foods having a strong odor or those that absorb odors easily should be covered.
- Vegetables, salads, etc. should be covered to retain their crispness.
- The coldest positions in the refrigerator are under the cooling fins and at the bottom of the refrigerator. The warmer areas are on the upper door shelves. This should be considered when placing different types of food in the refrigerator.

- Arrange all food in the unit to allow for free air circulation. Do not overpack because a stuffed refrigerator must work harder and will have higher cabinet temperatures.
- Do not leave the unit's door open any longer than necessary. This will reduce frost formation and increase the efficiency of the refrigerator.

FROZEN FOOD STORAGE COMPARTMENT

This compartment is not designed for deep or quick freezing of food.

- To prevent food from drying out, keep it in covered dishes, containers, plastic bags or wrapped in aluminum foil.
- Meat or fish, whether raw or prepared, can be stored in the frozen food storage compartment provided they are precooled first in the refrigerator. They can be stored about three times longer in the frozen food compartment as compared to the fresh food compartment.
- Quick frozen soft fruits and ice cream should be placed in the coldest part of the compartment, which is at the bottom of the aluminum liner.
- Frozen vegetables, may be stored in any part of the compartment.
- To prevent frost buildup, which can reduce efficiency, wipe excess moisture off items being placed in the compartment.

ICE CUBES

Ice cubes can be made in the freezer compartment. For faster freezing, place trays in direct contact with the bottom of the freezer compartment. Ice will be made more rapidly if the thermostat is set at its highest position, but be sure to move the thermostat back to normal setting when the ice is formed; the refrigerator might otherwise become too cold.

STORAGE COMPARTMENTS

REMOVING AND REPLACING THE SHELVES

-  1. Remove the shelf locks by inserting the tip of a flat bladed screwdriver into the slot of the locks. Turn the screwdriver counterclockwise and then remove the shelf locks from the wire shelf.



2. Slide the shelf to the left until bushings disengage, then tilt the shelf to one side at an angle while pulling forward.

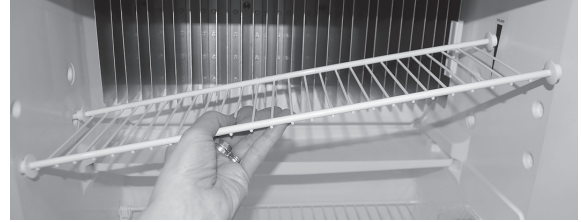

3. Reposition the shelf in the desired location. Insert the ends of the wire shelf on the left-hand side and slide the shelf into the holes on the right-hand side.
4. Slide the plastic plugs into the holes of the wall.
5. Snap the shelf locks onto the wire shelf.



PRODUCT CARE

AIRING POSITION CARD

Use the airing position card to keep the doors ajar if the refrigerator is put into storage or will not be used for an extended period of time.

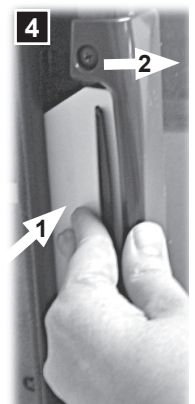
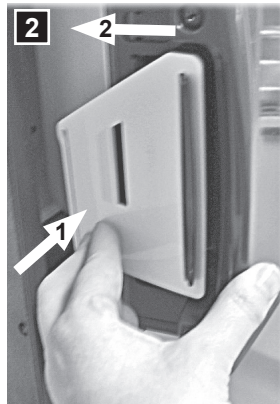

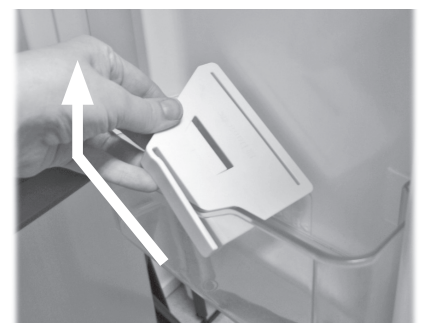
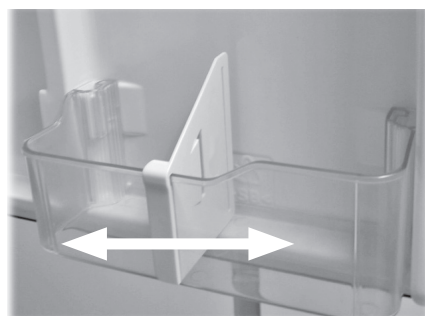
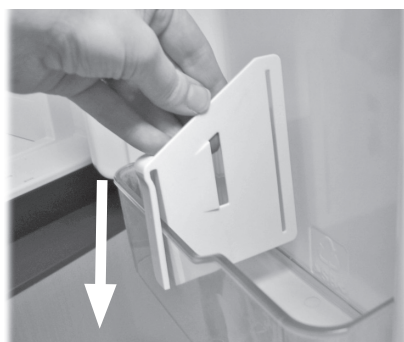

The card may be used as an adjustable partition in the door bin compartments. Press firmly until it snaps into place. To remove, tilt the card and detach.



PRODUCT CARE

DEFROSTING

- 
1. Shut off the refrigerator by pressing the main power ON/OFF button.
 2. Empty the refrigerator.
 3. Leave the cabinet and freezer doors open and make sure the drip tray is in place under the finned evaporator.



Defrosting time can be reduced by filling ice trays with hot water and placing them in the freezer compartment.

⚠ WARNING

FIRE AND INHALATION HAZARD. Do not use a knife, ice pick, or any other sharp tool to remove frost from the freezer compartment. Failure to obey this warning could cause a leak in the ammonia cooling system which could lead to a fire hazard resulting in death or serious injury.

An ammonia leak also poses an inhalation hazard, and could cause chemical burns to the skin and eyes. Exposure to a high concentration of ammonia could result in death or serious injury.

NOTICE

Do not use a hot air blower to remove frost from the freezer compartment. Permanent damage could result from warping the metal or plastic parts.

4. When all the frost has melted, dry the interior with a clean cloth and turn the refrigerator back on.
5. Set the thermostat to the coldest setting for a few hours. Then, reset the thermostat to the desired setting, usually at mid setting. Replace food after refrigerator has reached appropriate cool temperature.

STORAGE PROCEDURE/WINTERIZING THE REFRIGERATOR (ICE MAKER MODELS ONLY)

The refrigerator is equipped with a heater tape wrapped around the water solenoid valve and outlet water tube. During cold weather operation below 32°F/0°C the automatic temperature switch will turn the heater tape on automatically.

If the RV will not be in use for an extended period of time or put into storage:

- Drain the RV water system.

- Disconnect the water lines from the inlet and outlet sides of the water valve. Drain the lines into a cup and allow the lines to dry.
- The ice maker should be drained and dried. Note that this procedure must be performed by a qualified service technician.
- Using a lukewarm soda solution, clean the interior liner of the refrigerator. Clean the finned evaporator and shelves. Use warm water only and never strong chemicals or abrasives since these can damage the protective surfaces.
- Place doors in the airing position.

CLEANING

Always keep the refrigerator clean. Cleaning the refrigerator is usually done after it is defrosted or put into storage. Use lukewarm weak soda solution to clean the interior liner of the refrigerator. Use warm water only to clean the finned evaporator, gasket, and shelves. Do not spray liquid near electrical outlets, connections, or the refrigerator components.

After cleaning the interior liner/evaporator fins, make sure thermistor bulb and thermistor bracket are properly positioned. See "Troubleshooting" on page 14.

NOTICE

Do not use strong chemicals or abrasives to clean these parts, as the protective surfaces will be damaged.

To keep the refrigerator operating efficiently, periodic inspection and cleaning of several components once a year is recommended:

- Check the lower vent, upper vent, and area between these openings for any obstructions such as bird/insect nests, spider webs, etc.
- Make sure the refrigerator area is free from combustible material, gasoline, and other flammable vapors or liquids.

⚠ WARNING

FIRE OR EXPLOSION HAZARD. Do not store or use gasoline, oil or gasoline soaked rags, or other flammable vapors and liquids in the service area behind the refrigerator or in the vicinity of this or any other gas appliance. Failure to obey this warning could cause a fire or an explosion resulting in death or serious injury.

- If accessible, clean the coils on the back of the refrigerator. Use a soft bristled brush to dust off the coils.

MAINTENANCE & SERVICE

 To keep the refrigerator working properly, a qualified service technician should, at least once a year, inspect the connections, the control system, the LP gas pressure, and the flue baffle.

WARNING

FIRE AND INHALATION HAZARD. If the refrigerator stops working -or- if it emits an ammonia smell, immediately turn the refrigerator off, leave the vicinity, and contact a Service Center.

A high concentration of ammonia refrigerant could cause an inhalation hazard, could cause chemical burns to the skin and eyes, and could cause a fire resulting in death or serious injury.

REPLACING THE FUSES

The refrigerator is equipped with the following 3 fuses:

- 5 A fuse for 12 VDC.
- 5 A fuse for the AC heating element.
- 3 A in-line fuse for the fan and heat tape on ice maker models only.

TO REPLACE A FUSE, FOLLOW THESE STEPS:

-  1. Turn off the refrigerator and unplug the power cord.
2. Remove the 12 VDC power.
 3. Open the power module cover.
 4. Snap the fuse out of the fuse holder.
 5. Fit the new fuse in to the fuse holder.
 6. Close the power module cover.

PERIODIC MAINTENANCE

 To be performed by a qualified service technician only.

CHECKING THE LP GAS CONNECTIONS

-  1. Check all connections in the LP gas system (at the back of the refrigerator) for gas leaks. The LP gas supply must be turned on.
2. Apply an approved leak detection solution to all LP gas connections. The appearance of bubbles indicates a leak and should be repaired immediately!

WARNING

FIRE OR EXPLOSION HAZARD. Never use an open flame to check for gas leaks. Failure to obey this warning could cause a fire or explosion resulting in death or serious injury.

CHECKING THE CONTROL SYSTEM

Check the control system by connecting/disconnecting the 120 VAC power, starting/stopping the engine, etc.

CLEANING THE BURNER

-  1. Turn off the refrigerator.
2. Unplug the power cord from the 120 VAC outlet. Disconnect the wires or shut off the 12 VDC power supply to the refrigerator.
 3. Turn off the manual shut off valve.
 4. Remove cover from burner housing.
 5. Clean the burner tube with a brush. Blow out the burner with compressed air.

WARNING

FIRE HAZARD. Never use a wire or pin to clear obstructions from the burner jet as damage will occur. Do not attempt to adjust the burner jet. Failure to obey this warning could cause a fire resulting in death or serious injury.

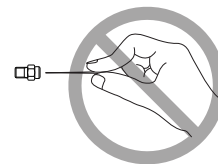

6. Verify that the burner jet slots are centered under the flue tube.
7. Be sure to check the burner flame for proper appearance. The flame should be clear blue over the slots of the burner.

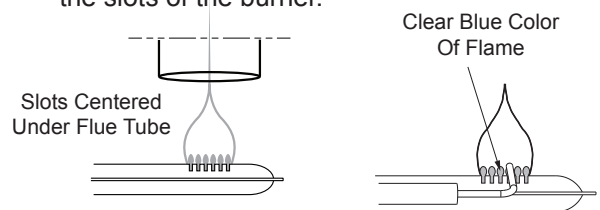

8. Check the electrode for proper location and gap. Adjustments may be made with needle nose pliers if necessary.

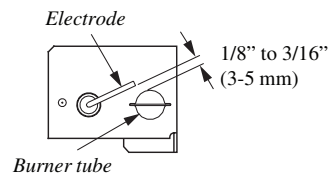

9. Turn on the manual gas shut off valve.
10. Examine all fittings for leaks. Use a commercial non-corrosive bubble solution.
11. Connect the 120 VAC power cord.
12. Reconnect / Turn on the 12 VDC power.
13. Check LP gas safety shutoff.

MAINTENANCE & SERVICE

REFRIGERATOR REMOVAL / DISPOSAL



To be performed by a qualified service technician only.

See Installation Instructions for refrigerator removal / replacement, and for recycle information.

TROUBLESHOOTING

TROUBLESHOOTING TABLE

If you run into a problem, refer to the troubleshooting table below. If an error code is displayed, please see “Error Codes” for more information.

SYMPTOM	CHECK/REMEDIAL ACTION
Refrigerator stops cooling	<ul style="list-style-type: none"> • Immediately turn refrigerator off and contact a Dometic dealer or Service Center. NOTE! Do not leave it running for an extended period of time, and never try to solve the problem by repeatedly restarting the refrigerator. • Do not use refrigerator until it has been repaired.
Refrigerator emits an ammonia smell	<ul style="list-style-type: none"> • Immediately turn refrigerator off at front control panel. • Do NOT open refrigerator doors. • Open coach windows and doors (to air out coach) and evacuate. • Turn off manual LP gas valve at rear of refrigerator. • Disconnect the 120 VAC power at rear of refrigerator. • Contact a Dometic dealer or Service Center for repair. • Do not use the refrigerator until it has been repaired.
Refrigerator or freezer is not cold enough	<ul style="list-style-type: none"> • Check the thermostat and adjust if necessary. • Is there a power failure? • Is the refrigerator level? (Due to the nature of its operation, it is important to keep an absorption refrigerator level.) • Door closing properly? Check the door gasket. • Heavy frost build-up on evaporator fins? To prevent frost buildup, do not leave the unit's door open longer than necessary. • Overpacked refrigerator? The unit will have to work harder if refrigerator is stuffed, and results in higher cabinet temperatures. Arrange food in the unit to allow for free air circulation.
Refrigerator does not work on electric	<ul style="list-style-type: none"> • Is the plug firmly connected to the receptacle? Is the receptacle energized? Check the receptacle by plugging in another appliance. • Is there a power failure? • Blown fuse. Turn refrigerator off and contact a Dometic dealer or Service Center for repair.
Refrigerator does not work in gas operation mode	<ul style="list-style-type: none"> • LP gas bottle empty? Change the gas bottle. • Air in the gas line? Remove air by repeating the ignition sequence. • If the problem persists, turn refrigerator off and contact a Dometic dealer or Service Center for repair.
Refrigerator emits an odor from fumes	<ul style="list-style-type: none"> • Dislocated or damaged burner. Turn refrigerator off and contact a Dometic dealer or Service Center for repair. • Dirty flue tube. Turn refrigerator off and contact a Dometic dealer or Service Center for repair.
“LP” is flashing (The message alternates between “LP” and the fresh food compartment temperature)	<ul style="list-style-type: none"> • LP gas ignition failed. The refrigerator went through a complete ignition sequence, and the burner did not light. Turn refrigerator OFF and then back ON to return to normal operation. • Air in the gas line? After changing a gas bottle or after a long shutoff period, the gas line is likely to be filled with air. You may have to repeat the lighting procedure (45 seconds) by turning the refrigerator off and on several times in order to purge the air out of the gas lines. • LP gas bottle is empty and needs replacing. • Obstruction in or on the burner or burner jet, or burner jet is clogged and should be cleaned. Turn refrigerator off and contact a Dometic dealer or Service Center for repair.

TROUBLESHOOTING

Refrigerator too cold	<ul style="list-style-type: none"> • Dislocated thermistor bracket. Clip thermistor bracket to last fin on right side of cooling flange and center vertically on fin. • Dislocated thermistor bulb. Position thermistor bulb inside thermistor bracket groove and center vertically in bracket.
-----------------------	---

If the problem persists and the refrigerator is still not working properly, turn refrigerator off and contact your nearest Service Center. State the problem, model, product, and serial number. These details are stated on the data label inside the fresh food compartment.

ERROR CODES

For information about error codes, refer to the following table. The codes are displayed flashing (alternating between temperature and message). If an error code is displayed, contact a Dometic dealer or Service Center.

After having solved the problem, turn refrigerator OFF and then back ON. The refrigerator will return to normal operation.

ERROR CODES	INFORMATION
E0	No communication between display and power module.
E1	Disconnected LP gas valve or hardware fault in the LP gas operation system. The refrigerator may still be operational on 120 VAC.
E2	A failure of the temperature sensor device or associated electronic circuitry has occurred. Make sure the sensor wire is connected.
E3	The cooling unit has malfunctioned. Contact a Service Center.
E4	DC voltage is out of range (exceeds or drops below the limit values, approximately 8-18 VDC).

APPENDIX A - SPARE PARTS

The following table displays commonly used parts which should be available from your Dometic Service Center.

SPARE PARTS	PART NO	MODELS
Air Position Card	3851206015	RM3762, RM3962
Baffle	2932667039	RM3762
	2932667047	RM3962
Burner	2930697079	RM3762, RM3962
Crisper, small	3850992029	RM3762
	3850992011	RM3962
Crisper, big	3850993027	RM3762
	3850993019	RM3962
Door reversing kit, right-left (door panels)	3851044010	RM3762, RM3962
Door reversing kit, left-right (door panels)	3851044028	RM3762, RM3962
Door shelf, lower	3850975024	RM3762
	3850975016	RM3962
Door shelf	3850974027	RM3762
	3850974019	RM3962
Door shelf, freezer	3850973029	RM3762
	3850973011	RM3962
Electrode	2932781012	RM3762, RM3962
Heater (120V, 325W)	3850644612	RM3762, RM3962
Lamp (12V, 10W)	200729000P	RM3762, RM3962

APPENDIX B - REARVIEW EQUIPMENT

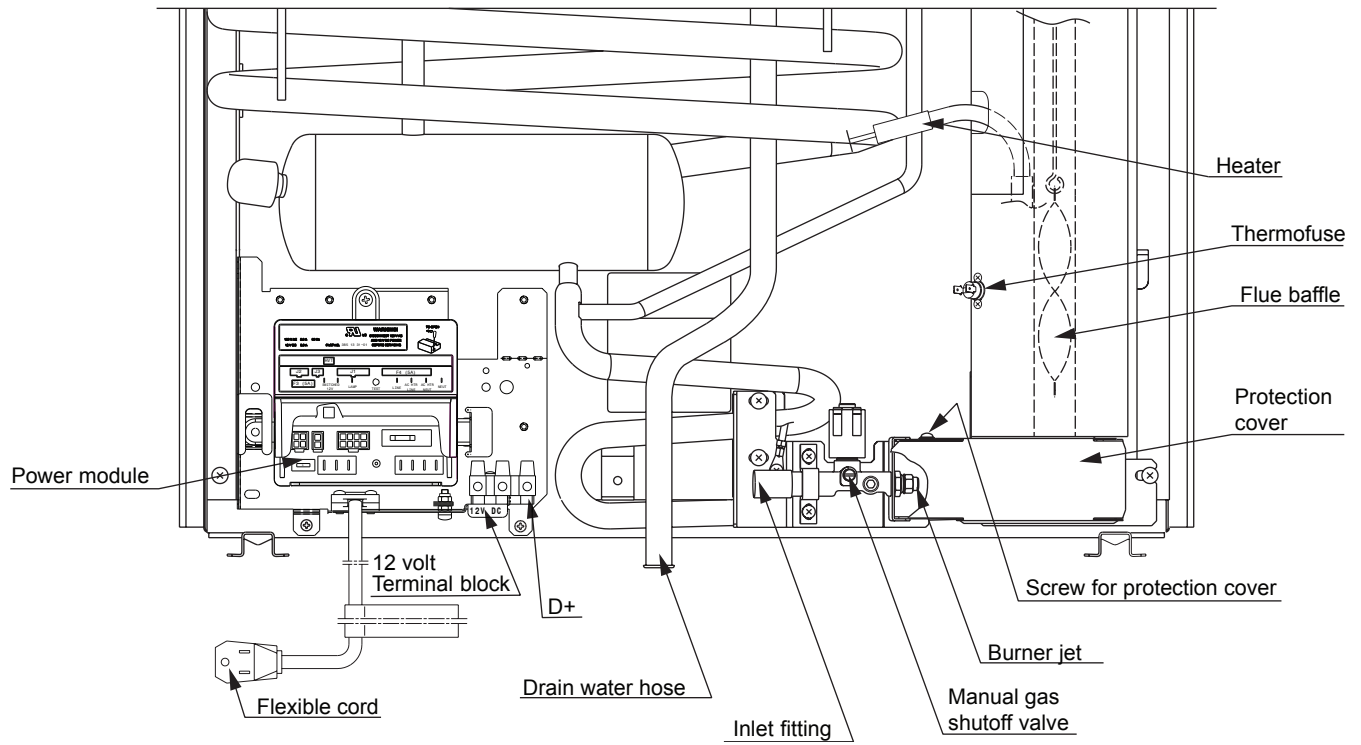

APPENDIX C - WIRING DIAGRAM

RM3762 & RM3962 (NO FAN) WITHOUT ICE MAKER

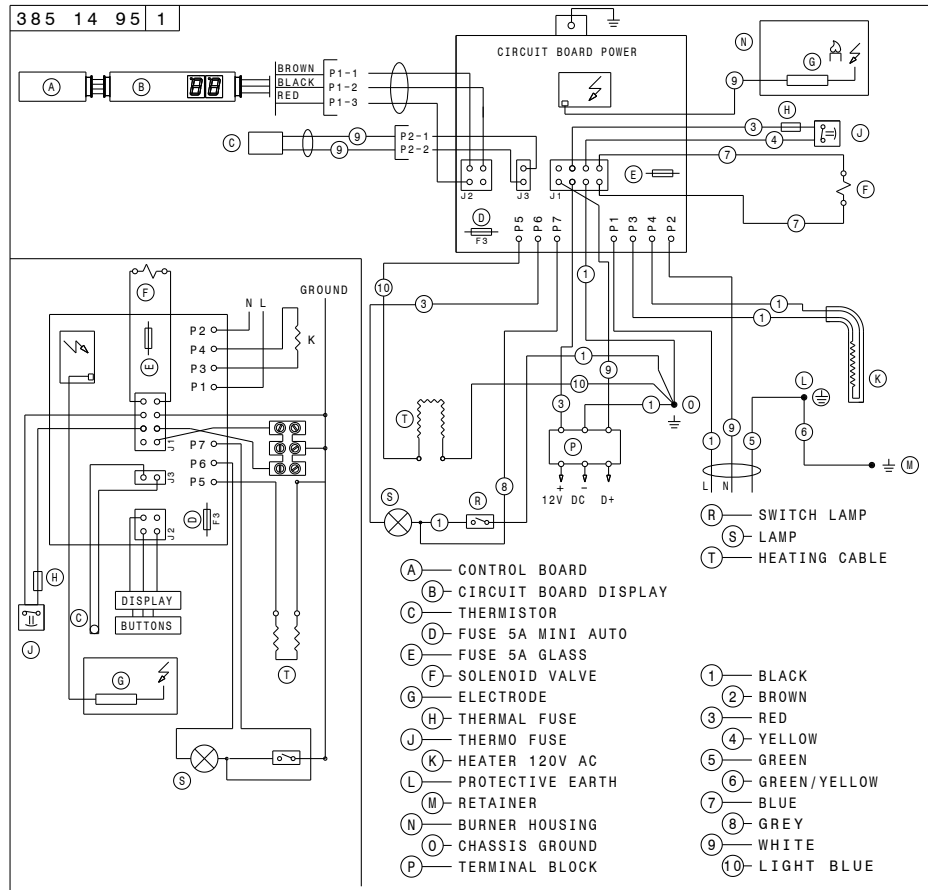

RM3762 & RM3962 (ONE OR TWO FANS) WITH AND WITHOUT ICE MAKER

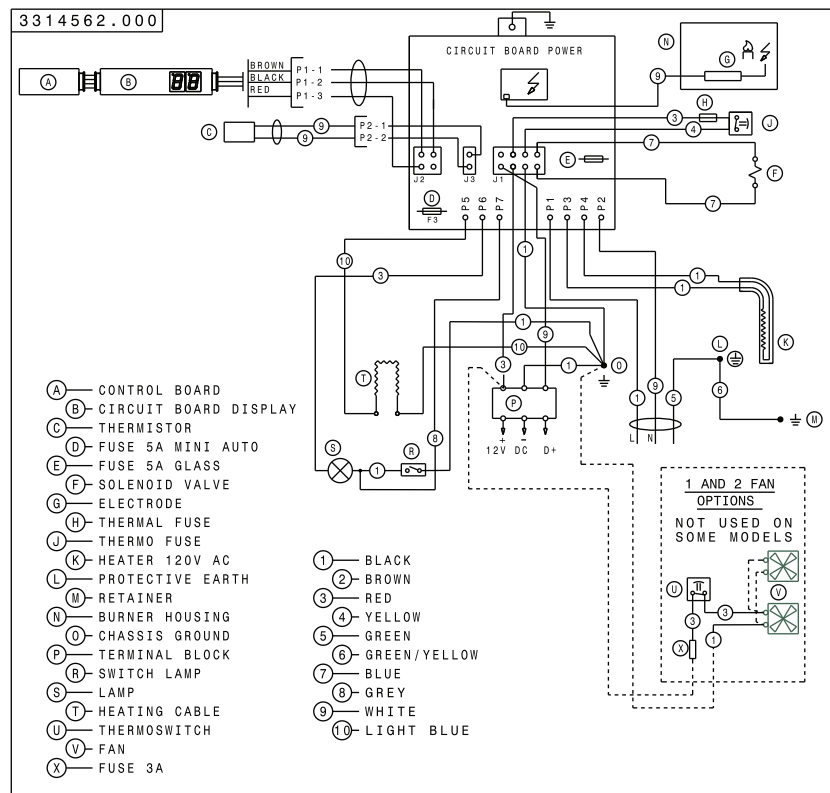

APPENDIX D - CONSUMER SUPPORT

Dometic website

www.DometicUSA.com

Please visit our website for information and news about Dometic products. Our website provides information on product care and warranties. You can also download product literature, including manuals and brochures.

Service and spare parts

www.eDometic.com

For service and spare parts, please contact Service Center Assistance. Please see the front page of this manual - or - visit our Dometic website to find a Dometic Service Center near you.

Contact us

www.DometicUSA.com

For contact information, please see the front page of this manual - or - visit our Dometic website.

Register product

www.eDometic.com

Timely registration allows for enhanced communication and service under the terms of your warranty. Please see "Appendix E - Dometic Warranty" on page (20).

To register your product, fill in the pre-printed registration card on the last page of this manual, or register on-line at www.eDometic.com.

TO REGISTER ON-LINE:

1. Access www.eDometic.com then click "Warranty Registration."

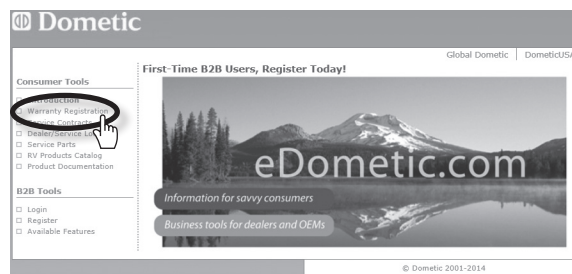

2. Click "Register your new Dometic product here!"

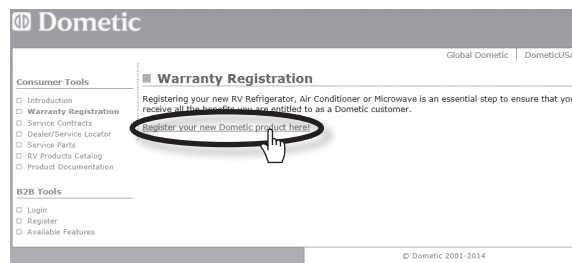

3. Complete the on-line form, then click "SUBMIT Registration."

The model number (e.g. RM3762) and serial number (e.g. 012 34567) are printed on the data label inside the refrigerator compartment.

APPENDIX E - DOMETIC WARRANTY

Congratulations, and **Thank You** for purchasing the industry's best built and best backed RV refrigerator. Dometic's exclusive two (2) year warranty is included along with important maintenance information. Please take a few moments to familiarize yourself with our warranty and maintenance program. We truly appreciate your business, and we are confident you will enjoy many years of trouble-free RV use.

LIMITED TWO-YEAR WARRANTY DOMETIC REFRIGERATORS THE SELLER NAMED BELOW MAKES THE FOLLOWING WARRANTY WITH RESPECT TO THE DOMETIC PRODUCT:

1. This warranty is made only to the first purchaser (herein after referred to as the "Original Purchaser") who acquires the product for his own use and is installed and operated within the continental United States and Canada.
2. This warranty will be in effect for two years on parts and freight and two years on labor from the date of purchase by the Original Purchaser. It is suggested that the original purchaser retain a copy of the dated bill of sale as evidence of the date of purchase.
3. This warranty covers only specified parts, which shall be free from defects in material and workmanship under normal use. This warranty does not cover conditions unrelated to the material and workmanship of the product. Such unrelated conditions include, but are not limited to: (a) damage not reported within the first 7 days of ownership; (b) faulty installation or installation that does not comply with RVIA standards, and any damage resulting from such; (c) the need for normal maintenance and any damage resulting from the failure to provide such maintenance; (d) failure to follow Sellers instructions for use of product; (e) any accident to or misuse of any part of this product and any alteration by anyone other than the Seller or its authorized representative; (f) any non-Dometic parts that are installed as replacement parts will void any warranty (implied or written); (g) flame outage due to blow out or high altitude; (h) reduced performance due to high altitude; (i) radio frequency interference and electromagnetic interference; (j) 12V system chassis ground decay and corrosion; (k) puncture of foam cabinet or vacuum insulated panels after acknowledged receipt; (l) animal or insect infiltration which damages unit or inhibits performance; (m) abuse or misuse of electrical components.
4. The specified parts covered by this warranty are as follows: Major components (cooling unit, LP gas valve, burner, burner housing, electronic display, electronic module, evaporator fins, foam integrity, frame, thermistor, spark probe, ignition wire, ice maker compressor, second absorption loop, display escutcheon, lower toe plate, humidity switch, frame heater mullion, ice maker mullion) are covered for parts and freight for two years and labor for two years from date of purchase. All other components that fail must be reported within the first 90 days of ownership in order to receive coverage of parts, freight and labor under warranty.
5. **This warranty requires the Original Purchaser to provide preventative maintenance on a yearly basis, starting at the anniversary of his date of purchase.** The Original Purchaser must keep a record of the preventative maintenance to keep the warranty in effect. Failure of the Original Purchaser in providing this annual maintenance may void the warranty. The preventative maintenance must be performed at a Dometic Authorized Service Center/Dealer. The preventative maintenance required is an inspection, cleaning and full diagnostics performed on the entire electronic system, burner assembly, wiring and cooling unit. A copy of the receipt covering the maintenance checks must accompany the warranty claim during the second year of ownership. The cost of this preventative maintenance is the Original Purchaser's responsibility and should take about one hour.
6. In order to obtain the benefits of this warranty, the original purchaser must return the product which is found defective to the Seller named below or to a Dometic Authorized Service Center during the period that this warranty is in effect. The original purchaser is responsible for all charges incurred in delivery of the product to the Seller or Dometic Authorized Service Center, and in pick up after the warranty service has been completed. To obtain the location of the nearest Authorized Service Center, please call 1-800-544-4881 or in Canada call 1-519-653-4390.
7. Any item returned in the manner described in paragraph 6 will be examined by the Seller or the Authorized Dometic Service Center. If it is found that the returned item was defective in material and workmanship, the Seller or the Authorized Dometic Service Center will repair the product per the terms outlined in paragraph 4. Confirm the service agency is an Authorized Dometic Service Center. DO NOT pay the service agency for Warranty repairs. Such payments will not be reimbursed.
8. The Seller does not authorize any person or company to create any warranty obligations or liability on their behalf. This warranty is not extended by the length of time which you are deprived of the use of the product. Repairs and replacement parts provided under the terms of this warranty shall carry only the non-expired portion of this warranty.
9. In no event shall either seller be liable for incidental or consequential damages. This includes any damage to another product or products resulting from such a defect. Some states do not allow the exclusion or limitation of incidental or consequential damages, so the above limitations may not apply.
10. Any implied warranty, including the implied warranty of merchantability and fitness for any purpose, is limited to the duration of this limited warranty. Some states do not allow limitations on how long an implied warranty can last, so the above limitation may not apply.
11. This warranty give specific legal rights, you may also have other rights which vary from state to state. No action to enforce this warranty shall be commenced later than ninety (90) days after the expiration of the warranty period. Claims must be submitted in writing to the Dometic Warranty Department for arbitration.
12. All products (except those specifically built for commercial use) are warranted only when installed in vehicles built to current edition R.V.I.A A119.2 and C.R.V.A. Z-240 Standards.
13. The Seller reserves the right to change the design of any product without notice and with no obligation to make corresponding changes in products previously manufactured.

DOMETIC CORPORATION
Warranty Department
1120 North Main Street
Elkhart, IN 46514

APPENDIX F - MAINTENANCE SCHEDULE

REFRIGERATOR OWNER MAINTENANCE YEARLY RECORD

Customer Name: _____ Model No.: _____ Date of Purchase: _____
 Address: _____ Serial No.: _____
 City: _____ State: _____ Zip Code: _____
 Phone: _____

FIRST YEAR

Date: _____
 Dealership: _____

 Address: _____

 City: _____
 State: _____ Zip: _____
 Phone: _____
 Technician: _____

Cleaned Burner Assembly: Yes / No
 Cleaned/Check All Terminals Connections: Yes / No
 Cleaned/Inspect All Ground Connections: Yes / No
 Inspect and Test Door Seals: Yes / No
 Inspect and Tighten LP Lines: Yes / No
 Power Ventilator Installed: Yes / No
 Gas Safety Shutdown in 45 seconds: Yes / No

	ACTUAL	SPEC. RANGE
Electrode Gap	_____	3/16"
Thermistor Reading	_____	7-10,000 ohms @ 32°
D/C Voltage	_____	9.5 to 15 volts D/C
A/C Voltage	_____	120 Volts ± 10%
Thermocouple Reading	_____	25-35 Millivolts
Delay Between Modes	_____	Approx. 5 seconds

ICE MAKER MODELS

Inspect Water Valve and All Connections: Yes / No
 Inspect Heat Tape Switch for Proper
 Operation: Yes / No

SECOND YEAR

Date: _____
 Dealership: _____

 Address: _____

 City: _____
 State: _____ Zip: _____
 Phone: _____
 Technician: _____

Cleaned Burner Assembly: Yes / No
 Cleaned/Check All Terminals Connections: Yes / No
 Cleaned/Inspect All Ground Connections: Yes / No
 Inspect and Test Door Seals: Yes / No
 Inspect and Tighten LP Lines: Yes / No
 Power Ventilator Installed: Yes / No
 Gas Safety Shutdown in 45 seconds: Yes / No

	ACTUAL	SPEC. RANGE
Electrode Gap	_____	3/16"
Thermistor Reading	_____	7-10,000 ohms @ 32°
D/C Voltage	_____	9.5 to 15 volts D/C
A/C Voltage	_____	120 Volts ± 10%
Thermocouple Reading	_____	25-35 Millivolts
Delay Between Modes	_____	Approx. 5 seconds

ICE MAKER MODELS

Inspect Water Valve and All Connections: Yes / No
 Inspect Heat Tape Switch for Proper
 Operation: Yes / No

REGISTRATION CARD

A. Protect Your New Investment

We truly appreciate your decision to purchase a new Dometic product, and we want to help you protect this wise investment.

We back our Dometic products with one of the most comprehensive warranties in the industry. Please complete and mail this registration card, or register your product on-line at www.eDometic.com.



TIME-DATED
MATERIAL
Please Process
Promptly!

Tape
Here

FIRST
CLASS
POSTAGE
REQUIRED



Warranty Department
1120 North Main Street
Elkhart, IN 46514

Tape
Here

■ **WARRANTY VERIFICATION**

Your prompt registration records your right to protection under the terms and conditions of your warranty.

■ **FACTORY COMMUNICATION**

Returning the attached card or registering on-line guarantees you will receive product information and specials. Including your email address will allow us to communicate with you quickly and efficiently.

■ **OWNER CONFIRMATION**

Your completed registration serves as confirmation of ownership in the event of product damage or theft.

■ **2 PLUS 3 SERVICE CONTRACT**

Returning the attached card or registering on-line ensures an invitation to upgrade to an optional 2 Plus 3 Full Service Contract. This service contract allows you to add up to 3 years of additional warranty coverage.



Return this card within **10** days to ensure your:

- WARRANTY VERIFICATION
- FACTORY COMMUNICATION
- OWNER CONFIRMATION
- 2 PLUS 3 SERVICE CONTRACT INVITATION

Fold here. Close with tape.

IMPORTANT:
Return Within
10 Days



Owner's Registration Card

Registering your product is an essential step to ensure you receive all the benefits you are entitled to as a DOMETIC customer. Complete the information below and mail to us, or register on-line at www.eDometic.com.

Be sure to include your email address, so we can communicate with you quickly and efficiently. Your address will remain confidential and will not be distributed to third parties.

Name

Address

City State/Prov.

Date of Purchase Zip/Postal Code

MO DAY YEAR

Email Address

- Email me exclusive offers and information on new products from Dometic.
- Email me offers and information from Dometic partners.

REFRIGERATOR MODEL NUMBER

SERIAL NUMBER

TO THE INSTALLER
PLEASE AFFIX THESE INSTRUCTIONS
TO THE REFRIGERATOR

TO THE CONSUMER
PLEASE RETAIN THESE INSTRUCTIONS
FOR FUTURE REFERENCE