

AIRSTREAM

A TRAILERING GUIDE

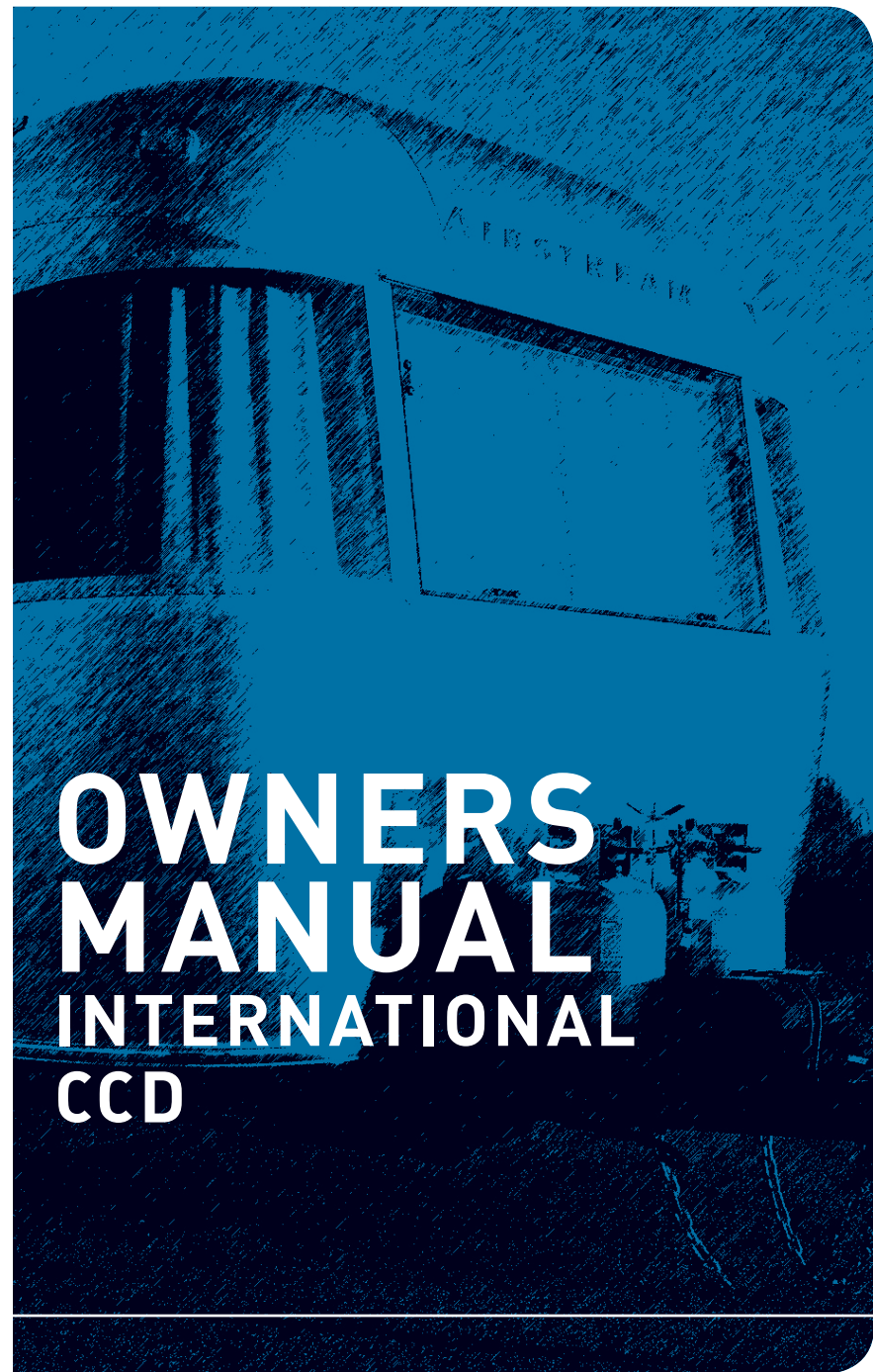

**OWNERS
MANUAL
INTERNATIONAL
CCD**

INTRODUCTION

2007 75TH ANNIVERSARY

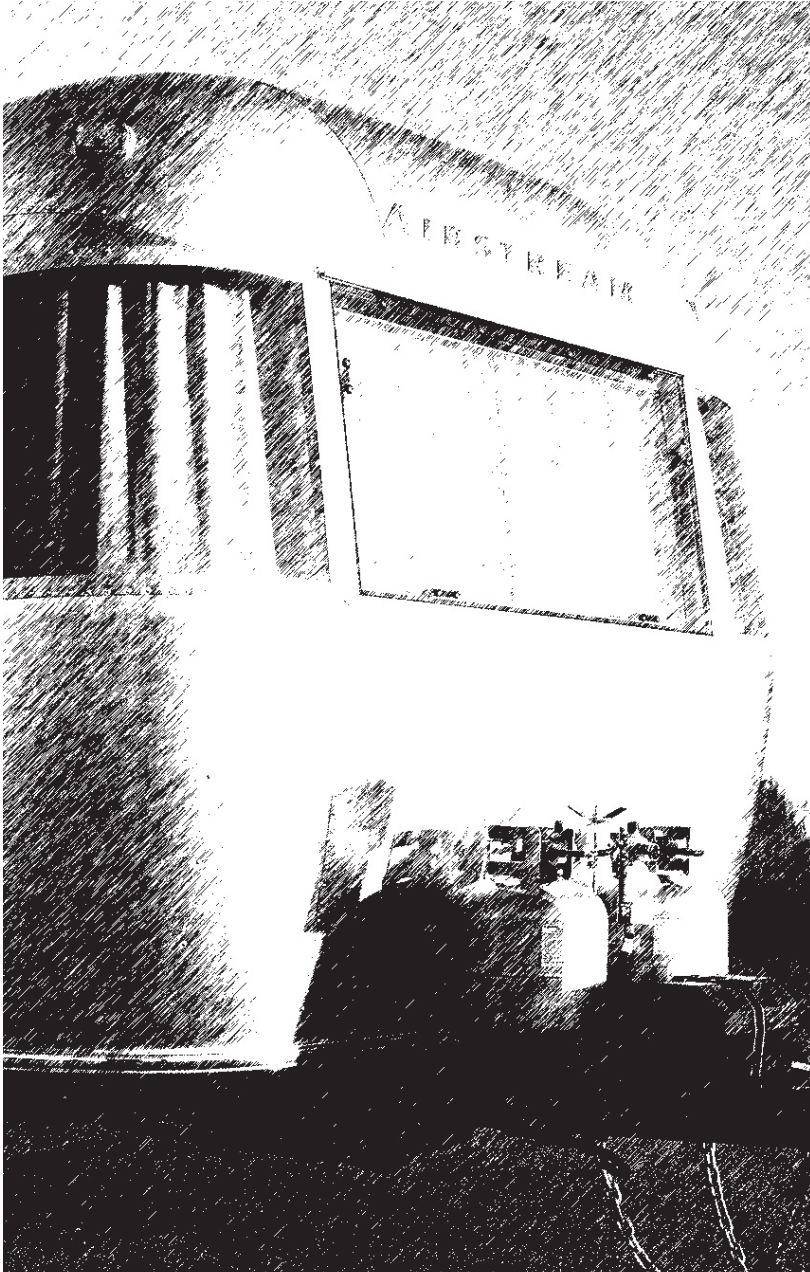

The Owners Manual for your new Airstream trailer is designed to respond to the most frequent inquiries regarding the operation, function and care of the many systems that make modern trailering a joy.

Airstream realizes our customers possess varying degrees of expertise in the area of repairing and maintaining the appliances in their trailer. For this reason, the service and trouble-shooting information found in this manual is directed toward those with average mechanical skills. We also realize you may be more familiar in one area than you are in another. Only you know your capabilities and limitations.

We want you to use this manual, and hope you will find the information contained in it useful, however, should you ever feel you may be "getting in over your head" please see your dealer to have the repairs made.

A brief explanation of the operation of the appliances such as refrigerator, furnace, water heater and others are explained in this manual. However, you will also find the manufacturer's information supplied in a packet included with this manual.

All information, illustrations and specifications contained in the literature are based on the latest product information available at the time of publication approval.

Throughout this manual **CAUTION** and  **WARNING** notations are used.

Failure to observe **CAUTION** can damage equipment.

 **WARNING** notes the possibility of personal and/or fatal injury if not observed.

Note: If and when new materials and production techniques are developed which can improve the quality of its product, or material substitutions are necessary due to availability, Airstream reserves the right to make such changes.

TABLE OF CONTENTS

A. WARRANTY AND SERVICE

Warranty
Warranty Explanation
Service
Reporting Safety Defects
Maintenance Schedule
Maintenance Parts & Supplies

B. TOWING

Tow Vehicles
Brakes
Loading
Weighing your Trailer
Hitching Up
Towing Tips
Pre-Travel Check List

C. CAMPING

Camping Safety
Overnight Stop
Extended Stay
Leveling & Stabilizing
Hook Ups
Winter Traveling
Prolonged Occupancy
Condensation

D. EXTERIOR

Cleaning
Chassis
Windows & Screens
Power Jack
Tires
Axle and Running Gear
Electric Brakes

E. INTERIOR FURNISHINGS AND ACCESSORIES

Fabric Care
Flooring & Fixtures
Features & Switches
Storage Areas
Smoke Alarm
LP Gas Detector
Fire Extinguisher

F. PLUMBING

LP (Liquid Petroleum) Gas
Water
Water Pump
Drainage
Winterizing
Drain and Waste
Toilet

G. ELECTRICAL

12-volt Operation
Battery
Converter
TV Antenna
Satellite Antenna
Solar Panel
Bathroom Exhaust
Monitor Panel
110-Volt System & Components

H. APPLIANCES

Air Conditioner
Furnace
Range/Oven
Refrigerator
Water Heater
Roof Vent, High Volume

I. SPECIFICATIONS

WARRANTY AND SERVICE



WARRANTY COVERAGE

When you buy a new Airstream Travel Trailer from an authorized Airstream dealer, Airstream, Inc., warrants the trailer from defects in material and workmanship as follows:

BASIC WARRANTY PERIOD

This warranty extends for a period of two years from the date of original retail purchase.

ITEMS COVERED

Any part of the trailer or any component equipment installed by the factory is covered by the basic warranty except the following items, which are not covered:

- Tires
- Batteries

The tire and battery warranties will be handled by their respective service points and according to their written policy. This limited warranty does not include failure caused by accident, abuse, normal wear, overload or any cause not attributable to a defect in original material or workmanship of the trailer or component equipment as installed by the factory.

LIMITATION OF IMPLIED WARRANTIES

All warranties of merchantability and fitness for a particular purpose, whether written or oral, expressed or implied, shall extend only for a period of two years from the date of original purchase. There are no other warranties, which extend beyond those described on the face hereof and which expressly excludes conditions resulting from normal wear, accident, abuse, exposure or overload. Some states do not allow limitation on how long an implied warranty lasts, so the above limitations may not apply to you.

AIRSTREAM'S RESPONSIBILITY

The basic **Airstream Limited Warranty** applies for a period of two years from the date of original purchase, and the application date of all warranties is that indicated on the owner's Limited Warranty. Defects in items covered under this Warranty will be corrected without cost upon the return, at the owner's expense, of the trailer or defective part to an authorized Airstream dealer.

WARRANTY AND SERVICE



CARE AND MAINTENANCE

This warranty covers only defective material and/or workmanship; adjustments are made at the factory prior to shipment, and rechecked by the dealer prior to delivery to the customer. Adjustments thereafter become a customer responsibility.

Each Airstream exterior (not including the underside) is clear coated to prevent oxidation. This application is covered by a two-year warranty against peeling. Prolonged exposure to salt air or industrial fall-out will permit penetration through the coating material, causing damage to the exterior finish. Since Airstream, Inc., has no control over these conditions, it is necessary for the owner to wash and maintain their trailer as instructed in the Owner's Manual.

The owner is also responsible for following all recommendations, instructions and precautions contained in the Airstream Trailer Owner's Manual and the individual manuals furnished by the chassis, appliance and other manufacturers.

INSTALLATIONS NOT COVERED

Airstream, Inc., does not accept any responsibility in connection with any of its trailers for additional equipment or accessories installed at any dealership or other place of business, or by any other party. Such installation of equipment or accessories by any other party will not be covered by the terms of this warranty.

IF REPAIRS ARE NEEDED

If your trailer needs repairs under the terms of the basic Airstream Limited Warranty, you should:

1. Take your trailer to your selling dealer or other Authorized Airstream Dealer.
2. If the dealer is incapable of making the repair, request that he contact the Service Administration Department at Airstream, Inc., for technical assistance.
3. If repairs are still not made, the customer should contact:

AIRSTREAM, INC.

419 W. Pike Street - P.O. Box 629
Jackson Center, Ohio 45334-0629
Attention: Owner Relations Department

Furnish the following information:

- The complete serial number of the trailer
 - Mileage
 - Date of original purchase
 - Selling dealer
 - Nature of service problem and steps or service, which have been performed.
(The owner may be directed to another dealer at the owner's expense.)
4. If, after taking the above steps, repairs are still not complete, the Airstream owner may request the trailer be brought to the Factory Service Center at the owner's expense.

WARRANTY AND SERVICE



DEALER REPRESENTATION EXCLUDED

The full extent of the basic Airstream Limited Warranty is set forth in detail in the folder, and in the explanation of the basic Airstream Limited Warranty covered in the Airstream Trailer Owner's Manual. Airstream Inc. will not be responsible for additional representations or implied warranties made by any of its dealers to the extent those representations are not a part of, or are contrary to, the terms and conditions of the basic Airstream Limited Warranty.

CONSEQUENTIAL AND INCIDENTAL DAMAGES

Airstream, Inc., will not be responsible for any consequential or incidental expenses or damages resulting from a defect. Incidental expenses include, but are not limited to: travel expenses, gasoline, oil, lodging, meals, telephone tolls, and loss of work and loss of use of the trailer. Some examples of consequential damages would be: stained curtains due to rain leaks or delaminated floor caused by a plumbing leak. *Some states do not allow the exclusion or limitation of incidental or consequential damages, so the above limitation or exclusion may not apply to you.*

WARRANTY TRANSFER

The basic **Airstream Limited Warranty** is transferable to subsequent owners for the duration of the warranty period. Warranty transfer application forms are available from your dealer or the Airstream Inc. Service Administration Department.

CHANGES IN DESIGN

Airstream Inc. reserves the right to make changes in design and improvements upon its product without imposing my obligation upon itself to install the same upon its products theretofore manufactured.

This warranty gives you specific legal rights, and you may also have other rights, which vary from state to state.

WARRANTY AND SERVICE

EXPLANATION OF AIRSTREAM LIMITED WARRANTY

The Airstream Limited Warranty is detailed in a separate folder. It is filled out by the dealer and presented to the owner during delivery of a new unit. The Limited Warranty must be presented to a dealer to obtain warranty service. It should be kept in the trailer during the warranty period.

EXCLUSIONS:

Normal Wear

Items such as tires, water purifier packs, curtains, upholstery, floor coverings, window, door and vent seals will show wear or may even wear out within the two year warranty period depending upon the amount of usage, weather, and atmospheric conditions.

Accident

We strongly urge our dealers and customers to inspect the trailer upon receipt of delivery for any damage caused by accident while being delivered to the dealer, or while it is on the dealer's lot. Damage of this nature becomes the dealer or customer's responsibility upon acceptance of delivery, unless Airstream is notified and the person making the delivery verifies the damage. Glass breakage, whether obviously struck or mysterious, is always accidental and covered by most insurance policies.

Abuse

Lack of customer care and/or improper maintenance will result in early failure for which Airstream cannot be held responsible.

Exposure

Not unlike a car, the steel parts of a trailer can and will rust if subjected to prolonged exposure to moisture, salt air, or corrosive air-borne pollutants without repainting. Aluminum oxidizes when unprotected under similar conditions, and refinery chemicals of a sulfurous nature are harmful to finishes if not washed off periodically. Extremely hot or direct sunlight will deteriorate rubber and fade curtains and upholstery. Conditions

of this nature, although they may be normal for the area, are beyond Airstream's control and become the responsibility of the owner.

It is the responsibility of the owner to take such preventative measures as are necessary to maintain the exterior caulking and sealer of your unit. It is the responsibility of the owner to use reasonable, prudent care to prevent foreseeable secondary damage from rain, plumbing leaks, and the natural accumulation of moisture in your unit, such as a delaminated floor; stained upholstery, carpeting, or drapes; mold formation and growth; furniture damage, etc. Mold is a natural growth given certain environmental conditions and is not covered by the terms of the Limited Warranty.

Overload

Damage due to loading, either beyond capacity or to cause improper towing because of improper balance, is beyond Airstream's responsibility. The Airstream trailer is engineered to properly handle the gross vehicle load rating on the certification label. Load distribution has a definite effect upon the towing characteristics and attitudes of the trailer. Level hitch installations are a necessity, and very important on a tandem axle trailer. There are limits to the amount of load that can be safely transported depending upon speed and road conditions, and reasonable cause to believe these factors have been exceeded could void the Airstream warranty. For additional information on the loading of your trailer, consult your Owner's Manual or gross vehicle weight rating plate.

The Airstream axle is manufactured to a tolerance of 1-degree camber and 1/8" toe-in. These tolerances will only change if the trailer is subjected to abuse, such as dropping off a sharp berm, striking a curb, or hitting a deep hole in the road. Such damage could be considered as resulting from an accident which risks are not covered under the warranty. Abnormal tire wear and/or wheel alignment resulting from such damage is not covered under the terms of the warranty.



WARRANTY AND SERVICE

SERVICE:

Before leaving the factory, each and every vital part of the trailer is tested for performance. Each test is signed and certified by an inspector. After the trailer arrives on your dealer's lot all of these vital parts and systems are again tested. When you take delivery of your new trailer you will receive a complete check out.

At that time a specified list of performance checks on your trailer equipment will be conducted and any deficiencies you have experienced since taking delivery will be corrected.

Please contact your dealer if you need service. Major service under your Airstream Limited Warranty is available through our nationwide network of Airstream Dealer Service Centers. An up-to-date list of Dealer Service Centers has been provided with your new trailer. This list is current as of the date of this publication.

Occasionally dealerships change, or new dealers are added who may not appear on this list. For this reason, it is suggested that you contact your local dealer from time to time and bring your list up to date. He can also provide you with additional copies if you need them. ALL CENTERS OPERATE ON AN APPOINTMENT BASIS FOR THE UTMOST EFFICIENCY.

When you require service from the Airstream Factory Service Center, or a Certified Dealer Service Center, please contact the service manager for an appointment, and kindly inform him if you are unable to keep the appointment date or wish to change it. Service may be arranged at the Factory Service Center by contacting the Service Coordinator at: Airstream Factory Service Center, P.O. Box 629, 419 W. Pike Street, Jackson Center, Ohio 45334-0629 Phone: 937-596-6111

REPORTING SAFETY DEFECTS

If you believe that your vehicle has a defect, which could cause a crash or could cause injury or death, you should immediately inform the National Highway Traffic Safety Administration (NHTSA) in addition to notifying Airstream, Inc.

If NHTSA receives similar complaints, it may open an investigation, and if it finds that a safety defect exists in a group of vehicles, it may order a recall and remedy campaign. However, NHTSA cannot become involved in individual problems between you, your dealer, or Airstream, Inc.

To contact NHTSA you may either call the Auto Safety Hotline toll-free at 1-888-327-4236 (TTY 1-800-424-9153) or write to: NHTSA, 400 Seventh ST. SW, Washington, D.C. 20590.

You can also obtain other information about motor vehicle safety from the Hotline or view the NHTSA Web site: www.safercar.gov

WARRANTY AND SERVICE



MAINTENANCE SCHEDULE



WARNING: FAILURE TO MAINTAIN YOUR COACH CAN CAUSE PREMATURE AND UNEXPECTED PARTS BREAKAGE AND/OR ERRATIC OPERATION THAT MAY BE HAZARDOUS.

Note: See appliance manufacturer's literature for further information

EVERY 1,000 MILES OR 60 DAYS

Escape Window	Check operation of latches and upper hinge.
*Battery	Check water level
Smoke Alarm	Test and replace battery as required.
Tires	Check tire pressure (See Specifications).
Hitch	Check for loose bolts or unusual wear.
GFI Circuit Breaker	Test and record.



WARNING: WHEEL SEPARATION CAN OCCUR

1. On first trip, tighten wheel lugs at start and at 10, 25, and 50 miles.
2. Thereafter, check wheel lugs before each trip.
3. Following winter storage, check before beginning a trip.
4. Following excessive braking, inspect wheel lugs

Torque wheels to 95 ft. lbs.

EVERY 5,000 MILES OR 90 DAYS

Exterior Door locks	Lubricate with dry graphite
Exterior Hinges	Lubricate with light household oil
LPG Hold Down	Lubricate with light household oil
LPG Regulator	Check bottom vent for obstructions
Main Door Striker Pocket	Coat with paraffin.
Wheel Lug Nuts	Torque wheels to 95 ft. lbs.
Break Away Switch	Pull pin and lubricate with household oil
7-Way Plug	Spray with contact cleaner.
Hitch Ball Latch	Lubricate with non-detergent motor oil
Hitch Ball	Lubricate with hitch ball lube or wheel bearing grease.
Range Exhaust Hood	Clean fan blades and wash filter.
Roof Vent Elevator Screws	Lubricate with light household oil
Main Door Step	Lubricate moving parts and check.

* As a battery ages and becomes less efficient, the water level should be checked at more frequent levels. Checking water level does not apply to Glass Mat Batteries.

WARRANTY AND SERVICE



EVERY 10, 000 MILES OR 6 MONTHS

Brakes	Inspect, adjust or replace as necessary
Wheel Bearings	Clean and repack
Tires	Inspect and rotate
Spare Tire Carrier	Lubricate moving parts.
Seals, Windows & Door	Clean with mild detergent and coat with "Slipicone".
TV Antenna	Lubricate all moving parts with silicone lubricant.
Exterior	Wax (Do not use an abrasive cleaner or wax).
Escape Window	Lubricate latches with WD-40.

EVERY YEAR

Battery	Clean, neutralize and coat terminals with petroleum jelly.
A-Frame, Step	Wire brush and paint frame at front and rear.
LP Bottles	Have purged by LP supplier.
Seams: Check and reseal exterior seams, windows, lights and vents as needed. Use Acryl-R seam sealer or equivalent.	
Hitch Coupler and Ball: Check for wear or damage. Assure all parts operate freely. Replace any component if worn or damaged.	

WARRANTY AND SERVICE



SUGGESTED MAINTENANCE PARTS AND LUBRICANTS

BULBS, EXTERIOR

Convenience Light (Dump Valve)	# 53, wedge base
License Plate, Clearance Lights	# 67
Door Light	# 1141
Tail light	LED

BULBS, INTERIOR

Shower, Exterior Compartment	# 1141
Round Ceiling Light	12V-10W

To change the bulb in the round ceiling light, first remove the lens assembly. The lens assembly is spring loaded and pops out of the fixture at its chrome ring. A small screwdriver may be used, be careful not to scratch the chrome and be sure the bulb is cool before attempting replacement. The bulb inserts into the ballast by two wire prongs. Grasp the bulb with a piece of cloth and pull it gently straight out from its ballast. Insert the new bulb, and replace the lens. The lens assembly has two grooves that must be aligned to the light fixture before snapping the lens back into place.



WARNING: Always replace the light bulb on an interior or exterior light fixture with the correct bulb for that light. Failure to heed this warning could cause fire, property damage, personal injury, or death.

FUSES

Radio	ATC 15 Amp
Battery Cable Fuses	SLC 50 Amp
(Canadian approved trailers only)	
Power Center	20 & 30 amp Automotive fuses
Battery Disconnect Relay	ATC 5 amp

12-VOLT BREAKERS

Location: just above the floor on roadside interior front end.	50 Amp Type 2
	30 Amp Type 2
	20 Amp Type 2

MISCELLANEOUS

Water Hose Gaskets	Wheel Bearing Grease
Extra Hair Pin Clips for Hitch	Grease Seals
Dry Graphite	WD-40 or Equivalent Aerosol Lubricant
Oil Can with 30 Weight Non-Detergent Oil	Silicone Lubricant
Light Household Type Oil	Spray Contact Cleaner
Hitch Ball Lube (May use wheel bearing grease.)	Exterior Seam Sealer

WARRANTY AND SERVICE



MAINTENANCE RECORD

DATE	DEALER	SERVICE PERFORMED

DATE	DEALER	SERVICE PERFORMED

TOW VEHICLE EQUIPMENT

If you plan to buy a new vehicle to tow your trailer, we suggest that you include in your purchase the towing options offered by most tow vehicle manufacturers. These include such things as a heavy-duty alternator and radiator, heavy-duty springs (See Note), shock absorbers, transmission cooler, heavy-duty fan and flasher unit and others, depending upon the make of the vehicle.

Transmissions may be manual or automatic, but an automatic transmission may prolong your tow vehicle's life and generally does a better job of controlling engine loads than the average driver using a manual shift.

Having adequate power is very important when considering the purchase of a new vehicle or the trailer towing capability of your present one. American manufacturers realize more than 30% of the vehicles they sell will be used for towing some type of trailer. The dealers are provided with guidelines to use when helping a customer decide on a tow vehicle. The guidelines are not just determined by the power output of the engine. The gear ratio of the differential is also a very important part of the guideline.

Inspect the vehicle's hitch regularly for loose bolts or nuts, cracked welds, loose ball mounts, and worn parts.

New trailerists often carry more food and other supplies than really needed. Remember that every item you take along is one more thing to stow and adds weight to the total load you must pull. Consolidate items in shelves, lockers, and in the refrigerator. It is better to have one full and one empty locker, than two half empty ones. Special care must be taken not to overload the front and rear ends of the trailer.

NOTE: Be realistic when ordering heavy duty springs. Only springs heavy enough to support your loaded vehicle (not including trailer) are necessary. Too harsh of spring rate will only shorten the life of the tow vehicle and trailer, and will make your journeys less enjoyable.

ELECTRIC BRAKES

The brakes are operated by 12 volt current from your tow vehicle and **MUST BE HOOKED UP SO THAT YOU HAVE AN INTEGRAL SYSTEM WITH YOUR TOW VEHICLE BRAKES.** To prevent problems and insure satisfactory braking action, install an electronic controller in line with the brakes in your tow vehicle.

An electronic controller installed in your tow vehicle will synchronize the trailer brakes with your tow vehicle brakes. It is designed to apply the trailer brakes with your tow vehicle brakes.

Your brake controller should be adjusted to provide for a slight lead of the trailer brakes over the tow vehicle brakes. Follow the directions provided with your controller and keep the information for future reference. Don't be afraid to ask questions! If you don't understand the directions, have the installer explain the procedures.

Due to normal brake lining wear, the brakes and the controller setting should be checked and readjusted, if necessary, during the trailer manufacturer's recommended inspection intervals.

Note: Brake lining adjustment should be periodically checked (fully) to be sure trailer brakes are in the same adjustment as the tow vehicles.

Properly set adjustments will provide for safe comfortable stops. They will also help assure optimum brake and tire life for both the tow vehicle and the trailer.

TOWING

BREAKAWAY SWITCH

B IN THE EVENT OF AN ACCIDENTAL SEPARATION of the tow vehicle and the trailer, the BREAK-AWAY SWITCH will set and lock the trailer brakes for a sufficient length of time to stop the trailer. The switch is activated when the wire attached to it and to the tow vehicle pulls out the small pin in the front of the unit. THIS PIN SHOULD BE PULLED OUT, LUBRICATED WITH LIGHT HOUSEHOLD OIL, AND REPLACED EVERY 90 DAYS.

To prevent corrosion within the breakaway switch, pull the switch's pin straight forward and spray the inside of the switch through the hole with an electric contact cleaner (such as Spra-Kleen) and re-insert pin. A drop of light household oil on the groove near the base of the pin will allow the pin to operate freely. WHEN THE TRAILER IS CONNECTED TO THE TOW VEHICLE, THE BREAKAWAY SWITCH LOOP SHOULD BE ATTACHED TO THE PERMANENT FRAME OF YOUR HITCH. When disconnecting the trailer from the tow vehicle remove wire loop from the frame. DO NOT REMOVE PIN FROM SWITCH BECAUSE THIS WILL APPLY THE TRAILER BRAKES.



WARNING: Do not use breakaway switch for parking brake.

7-way Plug Diagram

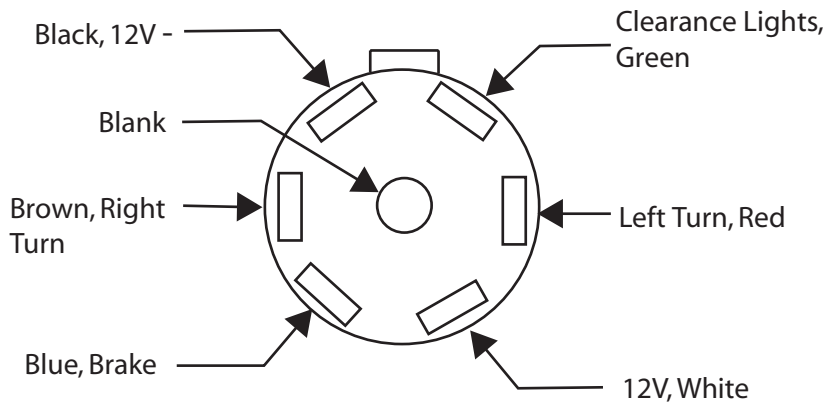

LOADING

Below is a sample of the weight information chart provided in all Airstream vehicles. This information can be found inside the wardrobe of the vehicle about 60" up from the floor on the side panel.

TRAILER WEIGHT INFORMATION

VIN OR SERIAL NUMBER

GVWR (GROSS VEHICLE WEIGHT RATING) IS THE MAXIMUM PERMISSIBLE WEIGHT OF THIS TRAILER WHEN FULLY LOADED. IT INCLUDES ALL WEIGHT AT THE TRAILER AXLE(S) AND TONGUE OR PIN.

UVW (UNLOADED VEHICLE WEIGHT) IS THE WEIGHT OF THIS TRAILER AS MANUFACTURED AT THE FACTORY. IT INCLUDES ALL WEIGHT AT THE TRAILER AXLE(S) AND TONGUE OR PIN. IF APPLICABLE, IT ALSO INCLUDES FULL GENERATOR FLUIDS, INCLUDING FUEL, ENGINE OIL AND COOLANTS.

CCC (CARGO CARRYING CAPACITY) IS EQUAL TO GVWR MINUS EACH OF THE FOLLOWING: UVW, FULL FRESH (POTABLE) WATER WEIGHT (INCLUDING WATER HEATER), FULL LP-GAS WEIGHT.

CARGO CARRYING CAPACITY (CCC) COMPUTATION		POUNDS	KILOGRAMS
GVWR		
MINUS UVW		
MINUS FRESH WATER WEIGHT OF	GALLONS @ 8.3 LB/GAL		
MINUS LP-GAS WEIGHT OF	GALLONS @ 4.5 LB/GAL		
= CCC FOR THIS TRAILER*		

*DEALER INSTALLED EQUIPMENT WILL REDUCE CCC

CONSULT OWNER MANUAL(S) FOR SPECIFIC WEIGHING INSTRUCTIONS AND TOWING GUIDELINES. CD-132

See specification section in this manual for definition and weight pertaining to this label.



WARNING: Never add items such as generators, heavy toolboxes or motorcycle racks to the back of the trailer. Weight behind the axle will tend to magnify any sway that may occur when passing trucks or in gusty wind. If a heavy generator is mounted on the rear bumper what may have been an almost unnoticeable sway turns into a severe sway you may not be able to control.

CAUTION: Damage to your trailer caused by mounting heavy objects on the rear is considered abuse, and is not covered by warranty.



WARNING: Never exceed the 100 lbs. rating on the bumper mounted receiver. Do not use the receiver for towing. Overloading behind the axle will tend to magnify any sway that may occur when passing trucks or in gusty wind. Overloading behind the axle and weight mounted on the rear bumper over the 100 lbs. maximum may turn what may have been an almost unnoticeable sway into a severe sway you may not be able to control and could cause structural damage to your trailer.



TOWING

WEIGHING YOUR TRAILER

The diagram below shows how to weigh the trailer on scales.



When loading heavy objects such as tools, skillets, irons, and boxes of canned goods, etc. keep them as low as possible - preferably on the floor. Try to hold additional weight behind the axle to a minimum.

CAUTION: The allowable personal cargo must be distributed in your trailer in such a manner that the Gross Axle Weight Rating is not exceeded.

To determine this, it is necessary to load all of your allowable personal cargo and variable weights. Then hitch the trailer to the tow vehicle with load equalizing hitch properly adjusted as shown on the following pages.

Place the trailer on a scale with both axles only on the scale (see 2). If the weight on the axles exceeds the axle system G.A.W.R. then some of the personal

cargo must be redistributed forward in order to place some of this weight on the tongue.

The tongue weight should be in between 10% - 15% of the trailer's total weight, but must not exceed the manufacturer's maximum recommended hitch weight of the tow vehicle or hitch. To determine tongue load, unhitch tow vehicle and place the tongue hitch post on a scale. The trailer must be properly loaded as determined above, with your allowable personal cargo and variable weights.

Used a scale, such as a bathroom scale, that has a lower weight limit than your tongue load to check the tongue weight by using the following method (see illustration).

Place a piece of wood of approximately the same thickness as the bathroom scales on the ground in

line with the trailer hitch jack as shown. It should be so spaced that a short piece of pipe or other round piece will lay exactly one foot from the centerline of the jack extension. Place the scales so that another round piece can be exactly two feet from the centerline of the jack extension in the other direction. Place a 4 x 4 on the two round pieces and screw the jack extension down on the top of the 4 x 4 until the tongue of the trailer is supported by it. Multiply the scale reading by three. This will be the tongue weight of your trailer. If you exceed the capacity of the bathroom scales, increase the two-foot dimension to three or four more feet, but always multiply the scale reading by the total number of feet between the wood and scales.

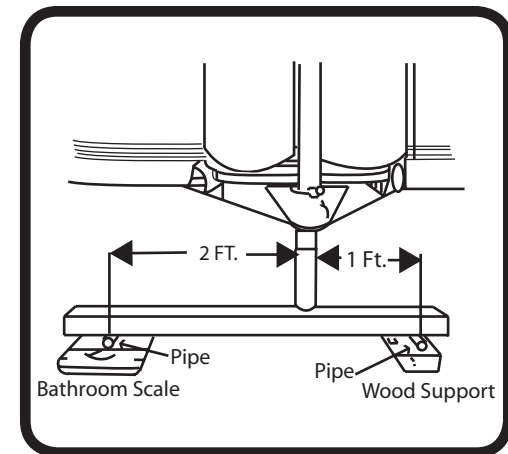

Note: Be sure trailer is level when you read scales.

HITCHING UP

Hitching up your trailer is something that will become almost second nature with practice. The following section includes proper hitch load distribution and a procedure for hitching up.

Equalizing Hitch Load Distribution

When a trailer is hitched up properly to a tow vehicle with a load equalizing hitch, approximately 1/3 of the trailer's tongue weight will be on the trailer's axles and 2/3 will be transferred to the tow vehicle, 1/3 of this weight transfer will be carried by the front wheels and 1/3 by the rear wheels of the tow vehicle (See diagram), Thus, the tire load of each wheel on the tow vehicle will be increased by 1/6 of the trailer's tongue weight. The tire air pressure of the tow vehicle should be increased to compensate for this additional weight. Refer to the vehicle's owner's manual for this information.

⚠ WARNING: The tongue weight should be approximately 10% to 14% of the trailer's total weight. Under no condition should it exceed the hitch rating. Your hitch installer should provide your hitch rating information to you.

Percentage of Tongue Load distributed to car and or trailer wheels

Proper installation

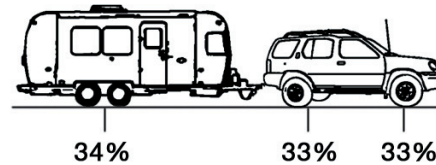

Hitch Low

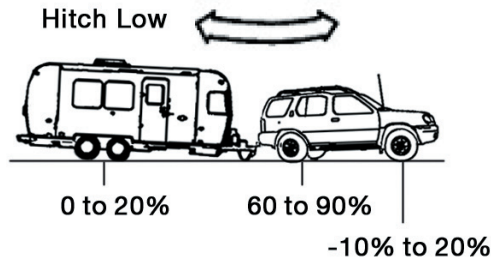

Hitch High

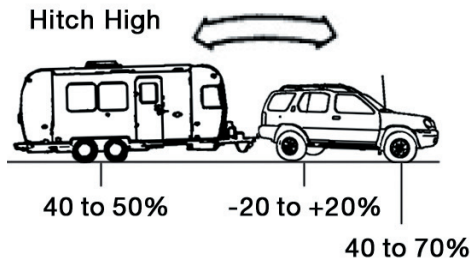

Sway Control Device

Although Airstream has not intruded into the hitch manufacturers field of expertise and preformed formal testing, we find the vast majority of Airstream owners purchases sway-control devices.

When passed by large trucks or when exposed to sudden crosswinds the trailer will be "pushed" and this action will be felt in the tow vehicle. It's our understanding the sway control devices will reduce the amount of movement and make towing more comfortable and add some safety.

Follow the directions of the sway control manufacturer when having it installed and using it.



TOWING

Steps for Hitching Up

The following steps are for a typical hitch system and are not meant to supersede instructions and training provided for the hitch installed on your tow vehicle. Please follow instructions and training provided with your hitch and its installer. The next page is provided for notes as needed on your hitch.

1. Jack up the trailer hitch until there is clearance for the HITCH BALL to slide under. Remove the safety pin, slide the locking lever forward and raise. Back the tow vehicle straight back to the hitch. This can best be accomplished through the use of prearranged hand signals with the help of another person; but if you are hitching up by yourself we recommend the use of a HOOK-UP VIEW MIRROR.

2. Lower the trailer hitch onto the hitch ball. Then close the locking lever and insert safety pin.

3. Now raise the trailer and tow vehicle to the full height of the hitch jack and then attach the LEVELING BARS. Lever the tension on the bars. Lower the tow vehicle and trailer.

The hitch ball should be level to slightly higher. Readjust leveling bars until this condition is correct by increasing or decreasing the length the chain engaged in "A" frame saddle bracket. Short chain raises hitch ball, longer chain lowers it. A level condition will result in the best balance for towing and steering control as

the weight-equalizing hitch distributes the hitch load.

A low hitch ball increases tail wagging tendencies by lowering the nose of the trailer, thus changing the center of support for the trailer and reducing the weight on the four wheels of the tow vehicle. With proper hitch installation and hitching up, the bar should have a noticeable amount of the deflection or bending. A little practice with your rig will teach you how far to pull the bar; you may wish to mark the chain links that match your rig.

Always choose level ground for checking correct hookup.

Note: If you're tow vehicle is equipped with adjustable load leveling air shocks, you must load the tow vehicle first with typical luggage and passengers and bring it back to level. Then attach the trailer and adjust the load leveling bars. Otherwise the air shocks on the tow vehicle will overload the rear wheels. **Do not use air shocks to level tow vehicle and trailer after hitching up.**

Note: Leveling the trailer end to end, then measuring from the ground to the inside top of the ball socket determines hitch ball height for the tow vehicle

4. Attach the safety chains to the welded portion of the hitch or tow vehicle's frame, but never to the removable ball mount. Cross the safety chains under the hitch.

5. Remove the jack pad and stow in the tow vehicle's trunk along with the leveling jack and other gear used when stopped.

CAUTION; Check that the foldaway step is up and LOCKED in its store position and that the main door is completely closed and the dead bolt LOCKED for towing. If they are not locked the constant vibration of travel may cause them to open with possible damage.

CAUTION; Retract the hitch jack completely for maximum ground clearance. **NEVER TOW YOUR TRAILER WITH THE JACK DOWN.**

6. Move the rig ahead about 50 feet and test the trailer brakes, then check the ground for forgotten objects. Regularly check the condition of your tires, air pressure, and the tightness of your lug nuts.

NOTICE!
CHECK WHEEL LUGS

On first trip, tighten wheel lugs at start and at 10, 25, and 100 miles. Tighten to 95 Ft. Lbs.. There after, check wheel lugs before each trip, after excessive braking, and following winter storage.

NOTES

B

TOWING

TOWING TIPS

A few hours of towing practice in a large empty supermarket lot will make pulling your trailer over the road much easier. Line out two corners for left and right turns. You may also use these corners to practice backing and parking.

After thoroughly inspecting your hitch, brakes, and tires you should be ready to tow. Check traffic, signal that you are about to pull away, and start slowly. Look often in your mirrors, and observe the action of the trailer, then carefully move into the proper lane of traffic. Remember that the trailer wheels will not follow the path of the tow vehicle wheels; therefore, WIDER TURNS ARE NECESSARY WHEN TURNING TO THE LEFT OR TO THE RIGHT.

We want every owner to be a safe and courteous driver. On a two-lane road cars may be lining up behind you because you travel at a lower speed. It is both courteous and sensible to signal, pull onto the shoulder, and let them pass. Your trailer is designed to be towed easily at any legal speed, so if you are not careful you may be inclined to forget it is there.

The BRAKE CONTROLLER is activated when you apply the brakes of the tow vehicle. Your tow vehicle brakes will automatically apply the trailer brakes first when properly adjusted. This will help keep your tow vehicle and trailer in a straight line and make you stop as if you were driving the tow vehicle alone. If swaying or swerving should occur, briefly operating the controller separate from the vehicle brakes may help correct the situation. Practice this maneuver on a clear highway. Don't wait for an emergency then grope for the controller.

When trailering you might encounter a temporary cooling system overload during severe conditions such as hot days when pulling on a long grade, when slowing down after higher speed driving, or driving long idle periods in traffic jams. If the hot indicator light comes on, or the temperature gauge indicates overheating and you have your air conditioner turned on, turn it off. Pull over in a safe place and put on your emergency

brake. Don't turn off the engine. Increase the engine idle speed. Lift the engine hood and check for fluid leaks at the radiator overflow outlet. Check to see that all drive belts are intact and the fan is turning. If you have a problem have it fixed at the next opportunity. If there is no problem, the light should go off or temperature should come down within one minute. Proceed on the highway a little slower. Ten minutes later resume normal driving.



WARNING: Never open a radiator cap when the tow vehicle is hot. Check the coolant level when the vehicle is cool. Read your tow vehicles owner's manual and follow all instructions on the cooling system.

Tracking

OBSERVE THAT THE TRACKS MADE BY THE TRAILER WHEELS ARE DISTINCTLY DIFFERENT FROM THOSE MADE BY THE TOW VEHICLE. Studying this will make it easier for you to correct mistakes. Truck or trailer type fender or door grip rear view mirrors are a must for maximum visibility and in most states the law requires them.

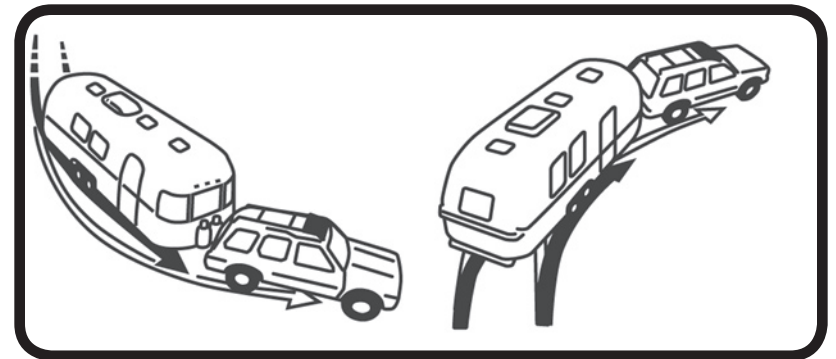

Passing

ON FREEWAYS OR EXPRESSWAYS try to pick the lane you want and stay in it. Always maintain plenty of space between you and the car ahead, at least the length of the tow vehicle plus trailer for every ten miles per hour. Remember that in order to pass another vehicle you will need longer to accelerate. You must also allow for the length of the trailer when returning to the right hand lane.

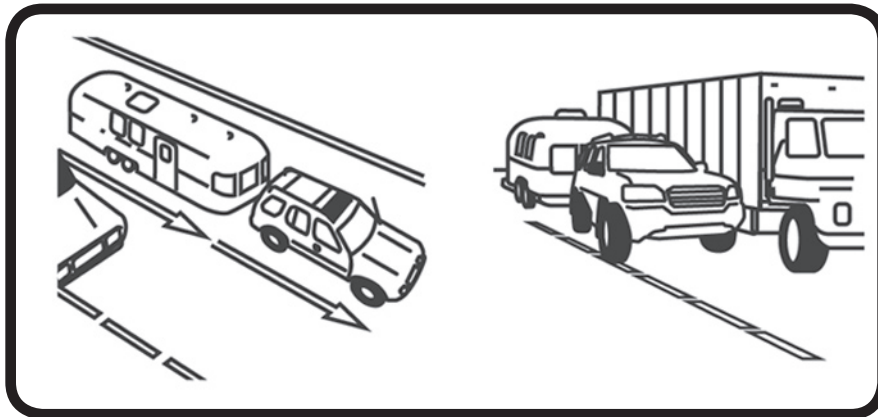

When going downhill in dry weather, down shift so that engine compression will slow the whole rig down. Take dips and depressions in the road slowly and do not resume normal driving speeds until you are sure that the trailer wheels are clear of the dip.



WARNING: On slippery pavement do not use engine drag to help slow down as this may cause the rear wheels of the tow vehicle to skid. On icy pavement drive slowly and if you feel the tow vehicle skidding gently apply the trailer brakes only. This will bring the tow vehicle and trailer back into a single line. Chains do not help trailer wheels.

CAUTION: When driving in mud and sand let the momentum carry the rig through. Apply power gently and use as little as possible. Stay in the tracks of the vehicle ahead and keep the tow vehicle in the highest possible gear. If you get stuck it is best to tow out the entire rig together without unhitching.

Despite the best hitch you will notice that whenever a large bus or truck overtakes your rig the displaced air first pushes the trailer rear slightly to the right and then affects the front. It may be necessary to steer very slightly, momentarily, toward the bus or truck to help compensate for the sway induced by the passing-vehicle. Do not apply the vehicle brakes, as this can tend to exaggerate the situation. You may find, however, that briefly applying the trailer brakes with your manual control will help eliminate sway.



WARNING: When stopping on a hill or slope, leaving your tow vehicle in gear is not enough for standstill safety. **CHOCK THE TRAILER WHEELS to be double sure. Do not use trailer brakes as parking brakes.**



TOWING

Backing Up

In BACKING UP the important thing to remember is to DO EVERYTHING SLOWLY and to correct immediately if you see the trailer turning the wrong way. Concentrate on the rear of the trailer. With your tow vehicle and trailer in a straight line back up slowly and turn the bottom of the steering wheel in the direction you want the trailer to go. Watch out the window or in the mirror until the rear of the trailer is pointing in the desired direction. Your vehicle will be following the trailer in an arc. Straighten the tow vehicle and trailer by turning the steering wheel more sharply, and then when they are in line, straighten the steering wheel.

ALWAYS TRY TO BACK TO YOUR LEFT BECAUSE THE VISIBILITY IS MUCH BETTER. (See Illustration) When you don't make it on the first try it is usually much easier to pull forward to your original position and start over.

If your spouse or traveling companion normally directs you when backing they should position themselves forward of the tow vehicle so the driver can easily see them. Their directions should always indicate to the driver the direction the rear of the trailer should go. A little practice in a parking lot with the person giving directions can save a lot of frustration when backing into a campsite.

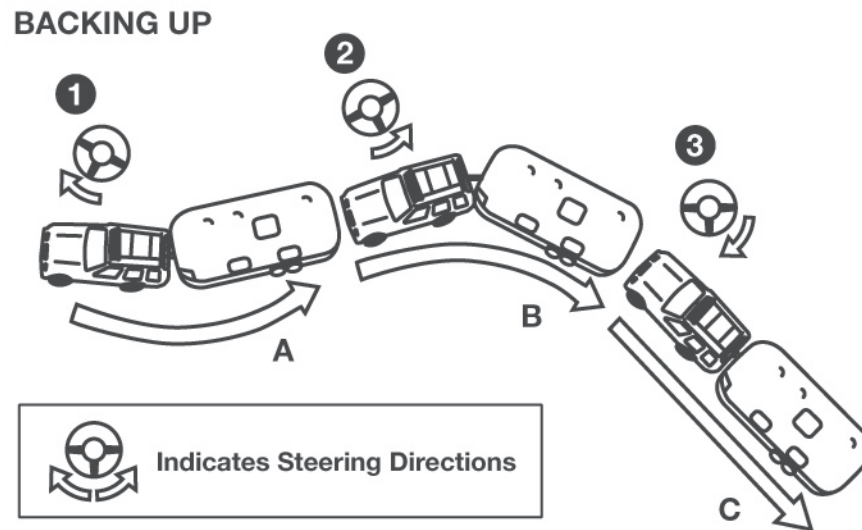

Position (A) start. Turn steering wheel as shown in (1) will put you in trailer Position (B). Turning steering wheel show in position (2) puts you in trailer position (C). Steering position (3) returns front wheels for straight backing.

SUGGESTED PRE-TRAVEL CHECK LIST

Interior

1. Turn off water pump switch.
2. Check battery water level.
3. Close windows and vents.
4. Lock all interior cabinet doors.
5. Latch refrigerator door. (Seal containers first.)
6. Hold down or stack securely all loose, hard and sharp objects.
7. Fasten sliding and foldette doors.
8. Drain toilet bowl.
9. Turn off interior lights.
10. Set table in upright position.
11. Pull up or retract step.
12. Lower blinds.
13. Secure and lock main door and dead bolt.

Exterior

1. Disconnect and stow the electrical hookup cord, the sewer hookup hose (flush out), and the water hookup hose.
2. Turn off gas at LP tanks.
3. Retract stabilizing jacks.
4. Check Hitch: It must be properly attached.
5. Check safety chains and breakaway switch cable.
6. Fully retract jack. Remove and stow jack stand, foot, or wood block.
7. Check clearance, turn signals, and stop lights.
8. Check lug nuts.
9. Check tires for correct pressure.
10. Check that TV antenna is properly stowed.
11. Lock main door dead bolt.
12. Adjust tow vehicle mirrors.

13. Pull forward some 50 ft., test brakes, and check site for forgotten objects and cleanliness.



WARNING: WHEEL SEPARATION CAN OCCUR

1. **On first trip, tighten wheel lugs at start and at 10, 25, and 50 miles.**
2. **Thereafter, check wheel lugs before each trip.**
3. **Following winter storage, check before beginning a trip.**
4. **Following excessive braking, inspect wheel lugs**

Torque wheels to 95 ft. lbs.

Home

1. Leave house key with your neighbors
2. Valuables and important papers should be stored in a safe place.
3. Newspaper, milk and other deliveries should be discontinued.
4. Ask the Post Office to hold your mail for you.
5. Arrange with the telephone company for discontinued or "vacation service".
6. Arrange care for your pets.
7. Your lawn, garden and houseplants should be cared for.
8. Lock all windows and doors securely. Keep shades open for a lived in look.
9. Cover all food to keep out mice and insects.
10. Eliminate all fire hazards. Place matches in a tin box or glass jar.
11. Store oil, gasoline, and other flammables properly.
12. Destroy all newspapers, magazines and oily rags.
13. Notify police of your departure and return dates.

TOWING

Trailer Equipment and Accessories

1. Water hose, 5/8 in. high pressure, tasteless, odorless, non-toxic, (or two 25 ft. sections).
2. "Y" connection for water hose.
3. The sewer hose with clamp.
4. Drain cap with hose drain.
5. Holding tank cleaner and deodorizer.
6. Power cord adapter 30-amp capacity.
7. 50 ft. electric cord, 12-3 wire, 30-ampere capacity.
8. 25 ft. electric cord, 10-3, 30-ampere capacity.
9. Woodblocks for leveling.
10. Wheel chocks.
11. Hydraulic jacks.
12. Cross type lug wrench.
13. Torque Wrench
14. Quality tire gauge.
15. Emergency road warning triangle.

Personal

1. Tow vehicle insurance to cover you and your family fully along with proof of insurance.
2. Try to avoid large amounts of cash. Use Travelers Checks and credit cards.
3. Confirm reservations.
4. Have sunglasses, sun block, and bug spray for everyone.
5. Pack camera and film.
6. Make a checklist of clothing for everyone, and toilet articles.
7. Prescribed medications.
8. Birth certificate, Passport.
9. Medical insurance cards.

Motoring Essentials

1. Display the tow vehicle and trailer registration properly.
2. Carry valid drivers license.
3. In Mexico you must have special auto insurance.
4. Carry an extra set of the ignition and truck keys in a separate pocket, or in your wallet.
5. Keep an operating flashlight with fresh batteries in the glove compartment.
6. Pack so that you can reach the tools and spare tire without completely unpacking.
7. Keep sharp or hard articles securely packed wherever they may be.
8. Do not packed things in the passenger seating area. You need the maximum space for comfort.
9. WEAR easy wash, drip-dry traveling clothes.
10. Do not make your vacation trips a mileage marathon. Stop and relax frequently.
11. Carry a first-aid kit.
12. Carry your pet's dish, food, leash, and health and registration papers.
13. In Canada you'll need a non-residence liability insurance card and birth certificate.

NOTES



CAMPING

SAFETY

Throughout this manual **CAUTION** and  **WARNING** notations are used.

Failure to observe **CAUTION** can damage equipment.  **WARNING** notes the possibility of personal and/or fatal injury if not observed. As always, safety should be one of your top priorities. Make sure you, and everyone traveling with you is familiar with and follows these cautions and warnings.

ESCAPE WINDOW OPERATION

Make sure you, and everyone traveling with you can operate the main door and the emergency exit window(s) rapidly without light. Contemplate other means of escape in case the designated exits are blocked. Run frequent emergency drills. The escape windows(s) are identified by red release handles and are opened by lifting up both latches, then turning the latches toward the center. Push out on the glass and it will swing clear. The window operation should be checked each trip and the latches lubricated with WD-40 or equivalent every six months. A loop is provided in the SCREEN RETAINING SPLINE so it can be rapidly removed. Take hold of the loop and pull the rubber spline out of the screen frame. The window screen can then be easily pushed out.

 **WARNING:** Learn and practice the escape window operation.

 **WARNING:** Check the emergency escape route outside your escape window at every stop. At each campsite make sure you have not parked in such a manner as to block the operation of the escape window by being too close to trees, fences or other impediments. Scenic views are one reason for traveling, but don't park so the beautiful lake or steep cliff is just outside your escape window. Never park your trailer so the escape windows cannot be easily used for emergency exits.

 **WARNING:** You and all your family should practice escape procedures so they can be rapidly accomplished even in total darkness. Never block the interior or exterior access to the emergency escape windows.

 **WARNING:** Read the directions carefully on the fire extinguisher. If there is any doubt on the operation, you and your family should practice, then replace or recharge the extinguisher. You will find your local fire department or any fire safety service will be happy to assist you and answer any questions.

 **WARNING:** Maintain and check smoke detector per its owner's manual recommendations.

 **WARNING:** Always shut off the LP gas when gasoline is added to the tow vehicle.

 **WARNING:**

- Don't smoke in bed.
- Keep matches out of reach of small children!
- Don't clean with flammable material!
- Keep flammable material away from open flame!

We have all heard these warnings many times, but they are still among the leading causes of fires.

Other safety information on the LPG system of your trailer is located in the plumbing section of this manual.

OVERNIGHT STOP

Airstream owners have parked virtually every place imaginable from filling stations to farmlands. In time you'll develop a knack for spying wonderful little roadside locations by turning off the main highway and exploring.

There are many modern parks including State, County and Federal parks with good facilities where you might obtain electrical, water and sewer hookups. Directories are published which described in detail these parks and tell what is available in the way of services and hookups.

On overnight or weekend trips chances are you will not use up the capacity of the sewage holding tank, deplete the water supply or rundown the battery which supplies the 12 volt current.

On a longer trip, when you have stayed where sewer connections and utility hookups were not available, it will be necessary for you to stop from time to time to dispose of the waste in the holding tank and replenish the water supply. Many gas stations (chain and individually owned) have installed sanitary dumping stations for just this purpose. Booklets are available which lists these dumping stations.

When stopping for the night, your Airstream is built to be safely parked in any spot that is relatively level and where the ground is firm. Your facilities are with you. You are self-contained. Unless the tow vehicle is needed for transportation, it is not necessary to unhitch.



WARNING: Do not parked in a manner that would prevent the escape windows from opening.

Try to pick as level a parking spot as possible. Stabilizing jacks or blocks probably won't be required during an overnight stay. However, if you put the jack pad on the hitch jack and run the hitch jack down to take the weight off the tow vehicle's springs this will provide some stability. If you must park on a slope, **PARK FACING DOWNHILL**. It is easier to level the trailer this way.

All you need to do to enjoy the self-contained luxury of your Airstream is to turn on the LP gas and light any appliances with pilots.

Before moving on, check your campsite for both cleanliness and also be sure you haven't left anything behind. Turn off the gas supply and make sure everything is properly stowed. Use your PRE-TRAVEL CHECK LIST and you are ready for more travel adventure.

CAMPING

EXTENDED STAY

Making a long trip in your Airstream is not very different from making a weekend excursion. Since everything you need is right at hand, you are at home wherever you go. When packing for an extended trip, take everything you need, but only what you need.

When you plan to stay in the same place for several days, weeks or months, you will want your trailer to be as level and steady as possible. Check the attitude with a small spirit level set on the inside work counter or the trailer hitch "A-Frame". (See Diagram Below) If a

correction is necessary then YOU MUST LEVEL FROM SIDE TO SIDE FIRST This can be done easily by backing the trailer up one or more 2" x 6" boards. We do not recommend placing tires in a hole for leveling.

LEVEL FROM FRONT TO REAR by disconnecting the hitch from the tow vehicle, putting the jack pad under the hitch jack and adjusting the jack up or down until you are level. Block or chock the wheels to keep the trailer from rolling. Use STABILIZING JACKS at the two rear corners as shown in the diagram to eliminate the natural spring action of the axles. STABILIZING JACKS should only be used to stabilize trailer.



WARNING: Whenever the trailer must be lifted with a jack, as when changing a tire or leveling on very rough terrain, ALWAYS PLACE THE LIFTING JACK UNDER THE MAIN FRAME RAIL. A label is provided to indicate the proper position for the jack. NEVER USE STABILIZING JACKS or HITCH JACK TO LIFT THE TRAILER.



Level side to side



Level front to rear



S H S
H-Hydraulic Jack Position
S-Stabilizing Jack Position

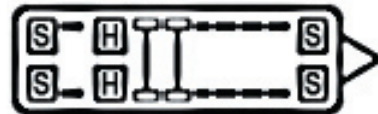

HOOK UPS

Hook up to **city water** by attaching a ½” minimum high-pressure water hose to the city water service. Be sure all drain valves and the water heater by-pass valves are in the normal use position and turn on the city water tap. Open the hot side of the galley or lavatory faucet. For some time the open faucet will only sputter. This is because the water heater is being filled and air is being pushed out through the lines. Once the water heater is full a steady stream of water will come from the faucet. Now open a cold faucet. It will sputter for a short time, but will soon expel a steady stream. All other faucets can now be opened until all air is expelled.

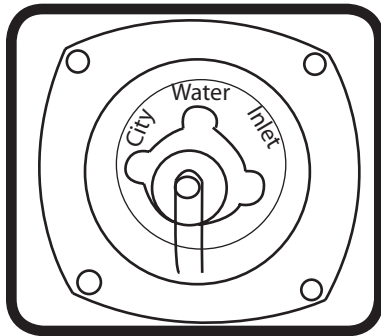

Once the system is filled with water and the faucets closed, the water system is now ready for use with the city water feed.

CAUTION: Hydrogen gas can be produced in a hot water system served by this heater that has not been used for a long period of time (generally two weeks or more). Hydrogen gas is extremely flammable. To reduce the risk of injury under these conditions, it is recommended that the hot water faucet be opened for several minutes at the kitchen sink before using any electrical appliance connected to the hot water system. If hydrogen is present there will probably be an unusual sound such as air escaping through the pipe as the water begins to flow. There should be no smoking or open flame near the faucet at the time it is open.

The Power Cord hook-up is on the roadside of the trailer. The cord may be stored in the rear exterior compartment. The power cord is plugged into the trailer receptacle and the City Power Service.

CAUTION: When operating with city power make very certain that the service is 110 volt and not 220 volt.

Hook your SEWER WATER DRAIN HOSE in the SEWER DISPOSAL FACILITY and attach to the drain outlet in your trailer.

Turn on gas supply. Light the range and oven pilots. Turn on the water heater, refrigerator and furnace.

When you stay for an extended period where electric or water hookups are not available, you must make regular checks on the charge condition of your 12-volt battery system. Hooking up the tow vehicle/trailer electrical connector and running the tow vehicle engine at a fast idle. 45 minutes per day should provide about 3-4 hours of power. Carry drinking water in a clean bucket to refill your tank. When your waste tank nears capacity move to a dumping location.



CAMPING

HOOK UPS

The exterior CABLE TV and TELEPHONE hookups are located on the side of the trailer. It is a gray dual inlet with weatherproof spring loaded caps.

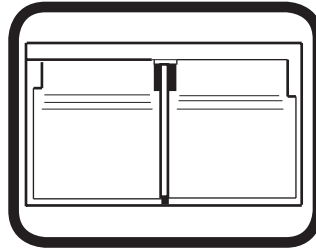

Interior TV hook-up location is on bedroom curbside wall.

Satellite TV hook-up location is on the curbside bedroom wall.

CABLE/SATELLITE TV WIRING

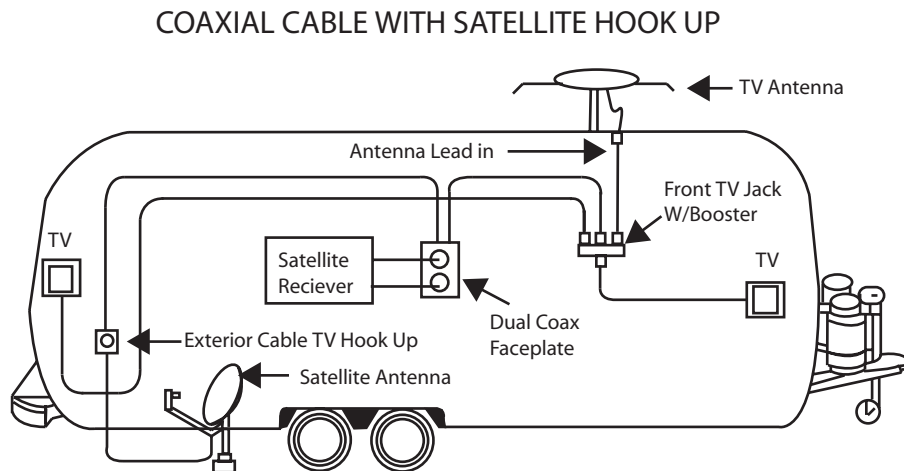
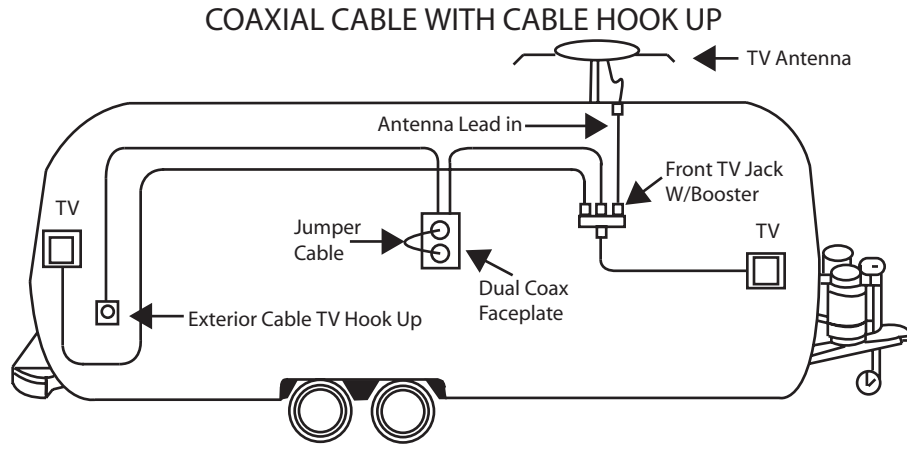

SATELLITE ANTENNA WIRING

If you compare the two drawings you'll see wiring for a satellite dish antenna is relatively simple.

Units have a faceplate with two coax cable hook-ups. The faceplate has a small coax cable jumper running between the hook-ups to complete the cable TV circuit when in use. To install a satellite system use the following procedure:

1. Remove the jumper wire from the coax faceplate.
2. Hook a portable dish into the Cable TV receptacle in the roadside rear underbelly compartment. This feeds the dish signal to the input side of the faceplate.
3. Install the satellite receiver input and output into the dual coax faceplate.

To return to a cable TV system, remove the satellite receiver from the faceplate and reinstall the jumper cable.

CAMPING

WINTER TRAVELING

Traveling in sub-freezing temperatures will require certain precautions to protect the plumbing system and your personal belongings from being damaged by freezing.

Whenever possible the heat should be kept on a constant temperature. It is easier for the furnace to keep a constant room temperature than for the trailer temperature to be allowed to drop 50 degrees Fahrenheit then attempt to raise it to a comfortable level.

The furnace supplies heat to the water lines and tanks. These pads are individually switched with the switch located next to the monitor panel. This feature allows the saving of battery power in a dry camping situation. To conserve battery power, RV antifreeze may be used to protect the gray and black tank. Battery power will last about 3 hours using all three heat pads.

Heat must be maintained inside your trailer to prevent the water lines and tanks from freezing. The exterior city water hose must be protected from freezing with heat tape.

CAUTION: If at any time the exterior temperature makes it difficult to maintain temperature inside your trailer above the freezing mark all winterizing procedures should be performed immediately. Freezing of liquid and solid wastes in the holding tanks could damage equipment.



WARNING: Always shut off the LP gas and be sure all flames are extinguished before gasoline is added to the tow vehicle.

Some states do not allow LPG to be turned on while moving. While traveling in these states you must use your common sense. How cold is it? How long will it be before you can turn the heat back on? Is the temperature dropping or raising? Remember, when towing at 50 MPH the wind chill factor will cause the interior of the trailer to cool much faster than a trailer that is parked.

When parked in sub-freezing temperatures make sure you keep a full supply of LP gas and plug into a 110 volt power source whenever possible. A fully charged battery will not last more than 8 to 10 hours if the furnace is running almost constantly and 110-volt power is not available.

Leave cabinet doors, wardrobes and bed doors partially open to allow warm air to circulate around plumbing lines and fixtures. Insulate and/or wrap your exterior water lines with heat tape.

EFFECTS OF PROLONGED OCCUPANCY

Your trailer was designed primarily for recreational use and short-term occupancy. If you expect to occupy the trailer for an extended period, be prepared to deal with condensation and the humid conditions that may be encountered. The relatively small volume and tight compact construction of modern recreation vehicles mean that the normal living activities of even a few occupants will lead to rapid moisture saturation of the air contained in the trailer and the appearance of visible moisture, especially in cold weather.

Just as moisture collects on the outside of a glass of cold water during humid weather, moisture can condense on the inside surfaces of the trailer during cold weather when relative humidity of the interior air is high. This condition is increased because the insulated walls of a recreation vehicle are much thinner than house walls. Estimates indicate that a family of four can vaporize up to three gallons of water daily through breathing, cooking, bathing, and washing. Unless the water vapor is carried outside by ventilation, or condensed by a dehumidifier, it will condense on the inside of the windows and walls as moisture, or in cold weather as frost or ice. It may also condense out of sight within the walls or the ceiling where it will manifest itself as warped or stained panels. Appearance of these conditions may indicate a serious condensation problem. When you recognize the signs of excessive moisture and condensation in the trailer action should be taken to minimize their effects. For tips on controlling condensation see the “Tips To Controlling Condensation” section.

Note: Your trailer is not designed, nor intended, for permanent housing. Use of this product for long term or permanent occupancy may lead to premature deterioration of structure, interior finishes, fabrics, carpeting, and drapes. Damage or deterioration due to long-term occupancy may not be considered normal, and may under the terms of the warranty constitute misuse, abuse, or

TIPS TO CONTROLLING CONDENSATION

Allow excess moisture to escape to the outside when bathing, washing dishes, hair drying, laundering, and using appliances and non-vented gas burners.

Always use the vent hood when cooking.

Keep the bathroom door closed and the vent or window open when bathing and for a period of time after you have finished.

Do not hang wet clothes in the trailer to dry.

In hot weather, start the air conditioner early as it removes excess humidity from the air while lowering the temperature.

Keep the temperature as reasonably cool during cold weather as possible. The warmer the vehicle, the more cold exterior temperatures and warm interior temperatures will collide on wall surfaces, thus creating condensation.

Use a fan to keep air circulating inside the vehicle so condensation and mildew cannot form in dead air spaces. Allow air to circulate inside closets and cabinets (leave doors partially open). Please keep in mind that a closed cabinet full of stored goods prevents circulation and allows the exterior temperature to cause condensation.

The natural tendency would be to close the vehicle tightly during cold weather. This will actually compound the problem. Simply put, you need to remove some of the warm air, and allow some cool outside air to get inside the vehicle, so the furnace will not recycle the humid interior air.

Use fluorescent ceiling lights and minimize prolonged use of incandescent lights, which produce heat and contribute to condensation in the roof above the ceiling lights.



CAMPING

ABOUT MOLDS

What are molds?

Molds are microscopic organisms that naturally occur in virtually every environment, indoors and out. Outdoors, mold growth is important in the decomposition of plants. Indoors, mold growth is unfavorable. Left unchecked, molds break down natural materials, such as wood products and fabrics. Knowing the potential risks is important for any type of homeowner to protect their investment.

What factors contribute to mold growth?

For mold growth to occur, temperatures, indoor or outdoors, must be between 40 degrees and 100 degrees Fahrenheit and also have a source of moisture, such as humidity, standing water, damp materials, etc. Indoors, the most rapid growth occurs with warm and humid conditions.

How can mold growth be inhibited?

By controlling relative humidity, the growth of mold and mildew can be inhibited. In warm climates, use of the air conditioner will reduce the relative humidity. Vents are located in the bathing and cooking areas and constant use is advised during food preparation and bathing, even during colder weather. Additionally, opening a window during these activities will assist in ventilation. In extremely humid conditions, the use of a dehumidifier can be helpful.*

Frequent use of your RV or cleaning regularly is an important preventive measure. Further, any spills should be wiped up quickly and dried as soon as possible. Avoid leaving damp items lying about. On safe surfaces, use mold or mildew killing cleaning products. Check sealants regularly, and reseal when necessary to avoid water leaks. Proper preventive maintenance to the RV and its accessories, as described both in this manual and in accompanying literature, will provide the best protection to the RV.

For more information of controlling moisture in the RV, please read, "Tips to Controlling Condensation," located in this manual.

*If using a dehumidifier, please read and follow all manufacturer instructions and recommendations to the use and cleaning of the dehumidifier.

NOTES



EXTERIOR

Cleaning

As a general rule of thumb we recommend the trailer be washed about every four weeks and waxed in the spring and fall. In industrial areas cleaning and waxing should be done on a more frequent schedule.

CAUTION: ABRASIVE POLISHES OR CLEANING SOLVENTS SUCH AS AUTOMATIC DISHWASHER OR ACID ETCH CLEANERS ARE TOO STRONG AND SHOULD NEVER BE USED. RINSE ALL GRIT FROM SURFACE PRIOR TO WASHING. Use soft rags or wash mitts always moving lengthwise with the trailer. NEVER rub hard on the coating. Even the softest rag will damage the coating if excessive pressure is applied.

ALWAYS CLEAN YOUR TRAILER IN THE SHADE OR ON A CLOUDY DAY WHEN THE ALUMINUM SKIN IS COOL. Oil, grease, dust and dirt may be removed by washing with any mild non-abrasive soap or detergent. Cleaning should be followed by a thorough clean water rinse. Drying the unit with a chamois or a soft cloth may prevent spots and streaks. WHEN WASHING OR POLISHING YOUR TRAILER, ALWAYS WIPE "WITH" THE GRAIN OF THE METAL.

Note: The polished rear bumper is clear coated with same coating used on the exterior skin and should be cleaned using the same precautions.

After cleaning and drying, a good grade of nonabrasive automotive paste or liquid wax will increase the life of the finish, especially in coastal areas where the finish is exposed to salt air or in polluted industrial areas. It will also protect the shell from minor scratches and make subsequent cleaning easier.

It is important to remove sap, gum, resin, asphalt, etc. as soon as possible after they appear by washing and waxing. Sunlight and time will bake-harden these materials making them almost impossible to remove without heavy buffing. If asphalt remains on the trailer after washing, use a small amount of kerosene on a rag and wipe the spots

individually, being careful not to scratch the finish.

If a substance is found on the coating that cannot be removed by normal washing procedures, Airstream recommends using DX 330 Acryli-Clean made by PPG Industries. Follow all directions and warnings on the product container. Acryli-Clean should be used by trained personnel only, using the proper equipment under controlled conditions. Use the Acryli-Clean as sparingly as possible to remove glue, tar, and other similar substance.

To keep your trailer looking new, paint the "A" frame, LPG tanks, and rear frame periodically.

It is recommended that the caulking and sealant used in external seams and joints such as end shell segments and around window frames, light bezels, beltline and rub rail molding, etc. be checked regularly. If this material has dried out and become cracked or checked, or if a portion has fallen out, it should be replaced with fresh material to prevent possible rain leaks. Caulking and sealing material is available from your Airstream dealer.

Precautions should be taken to prevent excessive sealant from getting on the coated surfaces. Remove excessive sealant before it cures using DX 330 Acryli-Clean made by PPG Industries as explained above.

CAUTION: It may be possible for solvents other than those recommended to extract materials from sealants that could stain the coated surface or could prove harmful to the sealants; therefore, these possible effects must be considered. Test a small area first.

Main Door

CAUTION: When towing, the door lock and dead bolt must be secured. If they are not locked, the constant vibration of travel may cause the door to open with possible damage.

Screen Door

The screen door secures to the main door by means of a slide bolt type latch. It can be operated independently by releasing the slide bolt and swinging the screen door away from the main door. For easier access to the interior main door handle, remember to leave the screen door plastic closeout in the open position when closing the main door.

Step

To operate the step, lift up and pull the step towards you, then lower the step down into position.



WARNING: Once the step is lowered, press down on it to make sure it is secure.

CAUTION: Never travel with step lowered or extended.

Exterior Windows

The windows in your trailer are safety glass. To open: release the two lever locks at the bottom, lift up on the two side operator handles until the window is in the desired position, and place the operators into one of the three positioning slots on the side of the frame. To lock the windows reverse this position



WARNING: Read and follow all warnings and escape window operation in the Camping section under Safety in this manual.

Clean your trailer windows the same way you clean the windows in your home. Clean the seals with a damp cloth or mild detergent every three to six months, taking care not to use strong solvents, as they will damage the seals. A coat of natural silicone lubricant applied after the seal has dried will keep it flexible. Spread the lubricant evenly with a brush or finger, working it into the surface. This is a good practice for all rubber seals in your trailer. For replacement of a damaged window contact an Airstream Service Center.

Your PLASTIC SCREENS are easy to maintain. Clean occasionally with a damp cloth. Note: They will melt at the point of contact if touched by a cigarette.

Awnings

Complete instructions have been provided with your awning. You should make sure your traveling companion is familiar with the operation of the awning. If a sudden wind should come up, or if high wind is forecast, the awning should be retracted, stowed and travel locks engaged. Awnings should be extended at an angle to encourage the run off of rain. Awning damage such as a bent tube, torn canvas, or broken arms due to high winds or water standing on the canvas are not covered by warranty. Use the center support bar if your patio awning is so equipped.

CAUTION: Travel locks on all awnings must be engaged before traveling.

EXTERIOR

Chassis

The standard RECOMMENDED HITCH BALL HEIGHT for your Airstream is listed in the "Specifications" section of this manual. If you plan long trips with the trailer heavily loaded, you should check your trailer, after loading, to determine the optimum height. To check, park the trailer on a level surface and crank the front jack up or down until the measurement from the frame to the ground is the same front and rear. Measure from the ground to the upper surface of the hitch ball coupler. Add one inch to this figure when setting the ball height on the tow vehicle to allow for the suspension settling under the added weight.

 **WARNING:** ALWAYS OPEN LATCH HANDLE BEFORE INSERTING BALL.

OPERATION INSTRUCTIONS

1. To open - slide forward and pull up to open latch before inserting ball
2. Place coupler on ball of same diameter as coupler and of same or greater capacity.
3. When ball is completely nested in socket, push top of latch handle rearward until handle snaps into closed position. (Figure 2)
4. Extend jack to ground and lift car/trailer combination 2-4" to insure coupler is securely attached to tow ball. Retract jack before towing.
5. Insert padlock through hole in handle for theft prevention.

POWER JACK

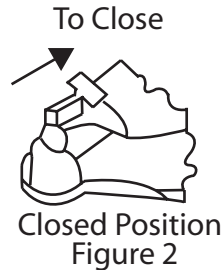
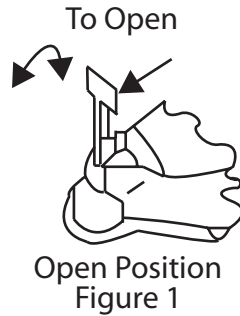

Hi-Power Acme 3,000

A switch located on the bottom of the housing operates the power jack. When the jack is fully extended or retracted internal limit switches automatically shut off the motor. The jack is wired directly to the battery with an inline fuse.

 **WARNING:** Keep hands and feet from under the footplate when using the jack.

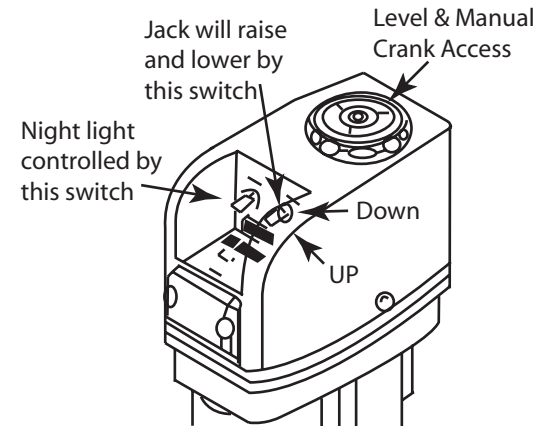

When the high-powered jack reaches the end of its travel, (either raising or lowering) internal limit switches automatically shut motor off.

Dolly wheels are not recommended.

 **WARNING:** Avoid the risk of injury to yourself and others.

- Use the jack for lifting the trailer only
- Never get beneath the travel trailer when only the power jack supports it.
- Support the vehicle by appropriate means.

If an electrical failure should ever occur the emergency handle may be inserted into the jack post and the jack can be raised or lowered. Access can be obtained by twisting the level cap off.

If the power head is removed the crank can still be used.

CAUTION: If power head is removed it must be synchronized with the jack post.

CAUTION: Leave tow vehicle transmission in neutral when lifting both units. Dolly wheels are not recommended. Always retract stabilizing jacks before using your jack under load.

 **WARNING:** Do not use the electric toggle switch (raise and lower) with the manual crank in place on the jack post. The crank will spin if the switch activates the motor and will cause serious injury. Use your battery disconnect switch to cut power to the jack.

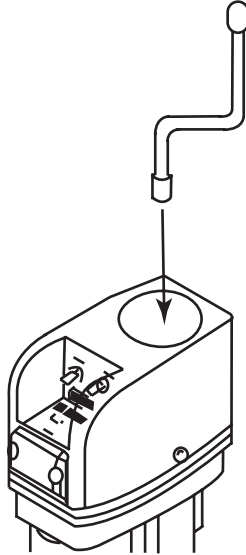

Maintenance

Once a year the power head should be removed and a liberal amount of grease (preferably a grease with high melting point) applied directly to the coupling on which the drive pin rests. DO NOT POUR OIL into the top of the jack post.

Once a year the housing cover should be removed and the gears inspected for proper lubrication. Remove 4 screws and tap around the edges of the housing to free the cover. DO NOT insert screwdriver blade, this may damage mating surfaces. If lubrication is needed, use Mobilith 460 grease or its equivalent.

AXLE AND RUNNING GEAR

Each RUBBER TORSION axle is aligned during manufacturing, and double-checked on a random basis. Alignment after delivery is the customer's responsibility.

CAUTION: Never allow heat to be applied to the axle tube since the rubber providing the spring torsion action will be severely damaged.

Hitting chuck holes or rough railroad tracks while going straight will only cause misalignment after the tire has been struck many repetitive times. Of course, a deep enough hole can affect the alignment immediately.

The worse culprit is a curb because they are normally struck at an angle. Surprisingly rear axles are occasionally damaged when people are attempting to park beside a curb and are backing up their trailer.

As you look under your trailer is it normal for the axle to be bent up in the middle. This bend is how the camber is obtained.

Toe-in is built into the axle by very slight bends in the axle tube on each end.

EXTERIOR

If tire wear ever indicate misalignment check with your dealer for the nearest location having the proper equipment.

Rubber torsion Axle Alignment Specifications

Toe-In each side 1/16"	Tolerance 1/16" + or -
Camber each side 3/4° positive	Tolerance 3/4° + or -

Wheel Bearing Maintenance

1. Jack trailer at marked jack location pad behind axle on mainframe.
2. Remove hubcap or spindle cover, wheel and tire.
3. Remove cotter pin.
4. Remove dust cap.
5. Remove spindle nut and washer.
6. Remove bearings, hub and rotor.
7. Lay down hub and rotor with inside grease seal down. Knock out inner bearing and grease seal using wood or plastic dowel and hammer.
8. Clean all parts thoroughly with kerosene.
9. Check all bearings and races for chips or roughness of any kind. Any damaged component must be replaced.
10. Pack bearing with a good grease (No 2 grade-265 ASTM penetration or equivalent).
11. Install inner bearing.
12. Install new grease seal in hub or rotor using wooden or rawhide mallet.
13. Install hub and drum on spindle.
14. Install outer bearing.
15. Install washer and spindle nut
16. While rotating the wheel, tighten the spindle nut with a 12" wrench until there is a slight tension. Then back off one notch and install cotter pin. There should now be from .001" to .010" endplay in hub. If not, back off one notch.

17. Check the lug nuts at 10, 25, and again at 50 miles of travel after replacing a wheel.

Torque wheels to 95 ft. lbs.

When greasing bearings by hand, place a glob of grease in the palm of one hand and push the large end of the bearing down into the grease (see illustration). Keep turning the bearing around and forcing it down through the grease until the grease is extruded up through the opposite end. Wipe the extra grease in your hand around the outside of the bearing. It's not necessary to fill the hub and dust cap with grease.

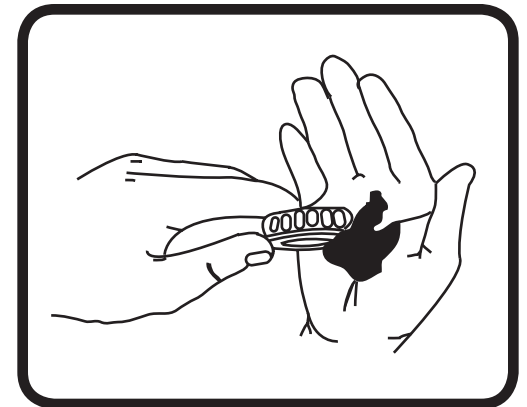

ELECTRIC BRAKES

A CONTROLLER installed in your tow vehicle will synchronize the trailer brakes with your tow vehicle brakes. It is designed to apply the trailer brakes whenever the tow vehicle brakes are applied.

TYPICAL ELECTRONIC CONTROLLER

ELECTRONIC CONTROLLERS are inertially activated. The controller senses deceleration and generates an output, which reflects the inertia sensed. When you are stationary, the controller does not apply the brakes unless the manual slide bar is activated.

NOTE: Study all material provided with your particular brake control. If you don't understand the information, have the installer explain the information to you or call the manufacturer of the controller.

In THE EVENT OF AN ACCIDENTAL SEPARATION of the tow vehicle and trailer, the BREAKAWAY SWITCH will set and lock the trailer brakes for a sufficient length of time to stop the trailer. The switch is activated when the wire attached to it and to the tow vehicle pulls out the small pin in the front of the unit. THIS PIN SHOULD BE PULLED OUT, LUBRICATED WITH LIGHT HOUSEHOLD OIL AND REPLACED EVERY 90 DAYS.

To prevent corrosion within the breakaway switch, turn you trailer battery disconnect to "STORE", pull the switch's pin straight forward and spray the inside of the switch through the hole with an electric contact cleaner (such as Spra-Kleen) and reinsert the pin. A drop of light household oil on the groove near the base of the pin will allow the pin to operate freely. WHEN THE TRAILER IS CONNECTED TO THE TOW VEHICLE, THE BREAKAWAY SWITCH LOOP SHOULD BE ATTACHED TO THE PERMANENT FRAME OF YOUR HITCH. When disconnecting trailer from tow vehicle remove wire loop from the frame. DO NOT REMOVE PIN FROM SWITCH BECAUSE THIS WILL APPLY THE TRAILER BRAKES.



WARNING: Do not use breakaway switch for parking brake or leave the pin out for longer than a few minutes with the battery disconnect in the "USE" position.

HOW TO USE YOUR ELECTRIC BRAKES PROPERLY

Your trailer brakes are designed to work in synchronization with your tow vehicle brakes. Never use your tow vehicle or trailer brakes alone to stop the combined load.

Your trailer and tow vehicle will seldom have the right amperage flow to the brake magnets to give you comfortable, safe braking unless you make proper brake system adjustments. Changing trailer load and driving conditions as well as uneven alternator and battery output can mean unstable current flow to your brake magnets. It is therefore imperative that you maintain and adjust your brakes as set forth in this manual, use a properly modulated brake controller, and perform the synchronization procedure noted below

In addition to the synchronization adjustment detailed below, electric brake controllers provide a modulation function that varies the current to the electric brakes with the pressure on the brake pedal. It is important that your brake controller provide approximately 2 volts to the braking system when the brake pedal is first depressed and gradually increase the voltage to 12 volts as brake pedal pressure is increased. If the controller "jumps" immediately to a high voltage output, even during a gradual stop, then the electric brakes will always be fully energized and will result in harsh brakes and potential brake lockup.

Proper synchronization of tow vehicle to trailer braking can only be accomplished by road testing. Brake "lockup, grabbiness, or harshness" is quite often lack of synchronization between the tow vehicle and the trailer being towed, too high of a threshold voltage (over 2 volts), or under adjusted brakes.

EXTERIOR

TIRES

Your trailer is equipped at the factory with name brand trailer tires. Airstream dealers cannot make adjustments to tires. A dealer who handles that particular brand must do this. If you ever have tire problems check the local telephone directory for the nearest dealer.

To get the maximum performance from your tires check the air pressure often, but only when the tires are cool. Never bleed out air immediately after driving. Recommended tire pressures vary with tire type and size.



WARNING: WHEEL SEPARATION CAN OCCUR

1. On first trip, tighten wheel lugs at start and at 10, 25, and 50 miles.
2. Thereafter, check wheel lugs before each trip.
3. Following winter storage, check before beginning a trip.
4. Following excessive braking, inspect wheel lugs

Torque wheels to 95 ft. lbs.

Try to park out of the sun whenever possible when in warm climates. In desert regions use tire covers to prevent ultra-violet deterioration to tires.

To CHANGE A TIRE with a jack see the label affixed to the underbelly to the rear of the wheels. This label, says JACK with an arrow and points to a plate riveted to the mainframe rail where the jack head must be placed. A flat tire may also be changed without the aid of a jack. Drive the unit up on a ramp 8" wide, 6" high, and about 3 feet long at its base. Position the good tire on the ramp. This will raise the flat tire clear of the ground.



WARNING: Never attempt to change any tire without securely chocking remaining wheels. Never position yourself in a manner where a raised trailer can come down on you if it should become dislodged from a jack or ramp.

All tire and wheel assemblies are balanced at the factory. Be sure to rebalance the tire and wheel assemblies each time a tire is changed.



WARNING: When removing aluminum-forged wheels, if so equipped, from the spindle, it is very important to mark them to assure the wheel is placed in the same position of the drum when reinstalling. If the aluminum-forged wheel is to be mounted on a different drum it is important to sand all loose corrosion from the mating surfaces.



WARNING: Whenever the trailer must be lifted with a jack, as when changing a tire or leveling on very rough terrain, ALWAYS PLACE THE LIFTING JACK UNDER THE MAIN FRAME RAIL. A label is provided to indicate the proper position for the jack. NEVER USE STABILIZING JACKS or HITCH JACK TO LIFT THE TRAILER.

In an emergency you may remove the flat tire. The independent suspension of the Rubber Torsion Axle allows four wheel units to be safely towed on three wheels for a short distance (100 miles maximum) and only at a low speed (30 MPH).

Be especially cautious in crossing holes or dips in the road. Under these circumstances it is good practice to set your rear view mirrors so that you can observe your tires at all times.

TIRE ROTATION

(10,000-mile intervals)

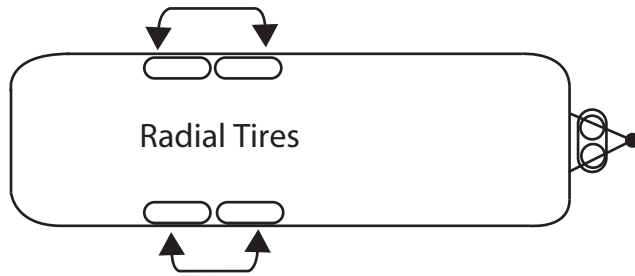

SPARE TIRE & CARRIER (Optional)

The spare tire for Airstreams is stored under the front of the trailer. The front handle of the tire carrier is a one-inch tube protruding out from under the front A-frame on the curbside. It is secured by a bracket and bolt along the inside of the A frame rail. Removing the bolts allows the front on the tire carrier to be lowered and the spare tire removed.

! WARNING: It is also important to periodically check on the tightness of lug nuts. Torque wheels to 95 ft. lbs. Care should be taken at all times when handling the wheel because of possible damage to its appearance.

NOTICE!

CHECK WHEEL LUGS

On first trip, tighten wheel lugs at start and at 10, 25, and 100 miles. Torque to 95 ft. lbs. There after, check wheel lugs before each trip, after excessive braking, and following winter storage.

! WARNING: Whenever the trailer must be lifted with a jack, as when changing a tire or leveling on very rough terrain, **ALWAYS PLACE THE LIFTING JACK UNDER THE MAIN FRAME RAIL.** A label is provided to indicate the proper position for the jack. **NEVER USE STABILIZING JACKS or HITCH JACK TO LIFT THE TRAILER.**



EXTERIOR

Load/Inflation Information for Your Tires

Maintaining proper tire inflation pressure is essential for both tire safety and performance.

Proper Tire Inflation

The level of air in your tires affects your vehicle's overall performance. Not even the highest quality tire will perform well if it's not inflated properly. The correct pressure varies from vehicle to vehicle and depends in part upon driver preference. Each vehicle has a maximum inflation pressure, usually found on a metal tag riveted to the outside of the vehicle as well as on the original equipment tires.

Correct tire inflation is a key component in tire care. The recommended inflation pressures for your tires are indicated on the certification label or in your owner's manual. Since RVs can be loaded with many different configurations, the load on each tire will vary. For this reason, air pressure should be checked based on the load on each individual tire. Cold Inflation Pressure should be adjusted to handle the maximum tire load, and all tires on the axle should carry the same inflation pressure. COLD TIRE INFLATION PRESSURE is the tire pressure checked in the morning before you drive more than a few miles or before rising ambient temperatures or the sun's radiant heat affects it. Check your tires' air pressures at least once a month, before each trip and each morning you drive during a trip. Tire pressure should be checked cold, as tire pressure ratings have been designed with typical running heat/pressure build-up in mind. Make sure the valves and caps are free of dirt and moisture.

Under Inflation

Under inflation brings a higher risk of damage due to road hazards, reduces casing durability, causes a loss in fuel economy, and uneven or irregular tire wear. Severe under inflation brings about an increased risk of tread separation, handling difficulties, and possibly tires failure, caused by overheating.

IMPORTANT: Lowering tire pressure in the search for a smoother ride is not only dangerous, it's relatively ineffective, and as the difference in the ride quality is not significant. When minimum inflation pressure requirements are not met, tire durability and optimum operating conditions are compromised. Tire inflation pressure should always meet the guidelines for vehicle weight.

- It may be necessary to inflate your tires at a truck stop or truck service center in order to achieve adequate air pressure for your coach's needs
- Only permanent air seal metal valve caps should be used.
- Be safe - if a tire has been run 20% under inflated, it must be dismantled and inspected by a trained professional. It should not be aired up without a full inspection or without using a safety cage. Use a calibrated gauge. If your tire is rated for higher inflation pressures, a special gauge will be required designed for larger tires.
- Don't bleed air from warm tires to reduce pressure buildup
- Don't inflate tires to cold PSI rating beyond rim specifications

HOW OVERLOADING AFFECTS YOUR TIRES

Tire pressure is what enables your RV tire to support loads. Overloading your tires can have serious consequences for passengers and your RV. Too much weight can cause stress on your RV's suspension system, brake failure, shock absorber damage, handling and steering problems, irregular tire wear and possible tire failure. Excessive loads or under inflation can lead to an excessive amount of heat and tire failure. If you discover that your tires cannot handle the load, lighten the weight of the load on your tires.

Tire pressure should never be reduced below the vehicle manufacturer's recommended levels to support load conditions in order to improve the ride quality of a vehicle. The difference in ride quality is not significant. When inflation pressure requirements are not met, tire durability and optimum operation can be affected.

Notes



INTERIOR

CLEANING

The interior of all Airstream trailers has been designed for comfort, convenience, durability and appearance. How you use it and how you take care of it naturally depends on you. However, if you learn to operate the interior components and take care of them and the trailer properly, this knowledge will add to your pleasure as well as the long life of your trailer.

The lounge and curtain fabric should be cleaned regularly before substances such as dirt, roof particles, etc. are allowed to accumulate on and become embedded in the fabric. The fabric can be cleaned without being removed from the installation. Simply brush off any loose dirt, roof particles, etc.; hose down and clean with a mild solution of mild soap in lukewarm water (no more than 100 degrees F). Rinse thoroughly to remove soap. **DO NOT USE DETERGENTS.** Allow to air dry.

For more stubborn cases: Soak the fabric for approximately twenty minutes in a solution of no more than 1/2 cup (4 oz.) of a non-chlorine bleach and 1/4 cup (2 oz.) mild soap per gallon of water at approximately 100 degrees F. Rinse thoroughly in cold water to remove all of the soap. Note: Excessive soaking in non-chlorine bleach can deteriorate sewing threads. This method of cleaning may remove part of the water repellency and the fabric should receive an application of an air-curing fluorocarbon water repellent treatment, such as 303 Hi Tech Fabric Guard, if water repellency is a factor.

How Can You Get Service? Call the dealer or retailer from whom you purchased the product, to inspect the claim. They, in turn, will contact the manufacturer of the item purchased. The manufacturer will then contact Glen Raven and secure replacement fabric for you.

Glen Raven Custom Fabrics, LLC
1831 North Park Ave.
Glen Raven, NC 27217-1100

(336) 221-2211

Fax: (336) 586-1169

www.sunbrella.com

CAUTION: Never remove cushion cover for separate dry cleaning or washing. Any tumble cleaning method can destroy the backing, shrink or otherwise damage upholstery fabric.



WARNING: Keep your furniture and family safe from fires caused by careless smoking. Do not smoke when drowsy. Remove immediately any flowing ash or a lighted cigarette, which falls on furniture. Smoldering smoking material can cause upholstered furniture fires.

CAUTION: Mattress covers must be professionally dry-cleaned.

Aluminum Mini Blinds

Blinds operate as most standard blinds and may be dusted with a damp cloth.

Vinyl Floor

The vinyl floor in your unit can be cleaned with liquid floor cleaning solutions recommended for vinyl floors and warm water.

Interior Panels and Cabinet Areas

These areas are laminated with a high-pressure veneer and can be cleaned with soap and water, or you can use a common solvent on tough spots. Be sure no abrasive cleaner is used, as there is the possibility it could scratch the surface.

Vinyl Counter Tops

These areas are laminated with a high-pressure veneer and can be cleaned with soap and water, or you can use a common solvent on tough spots. Be sure no abrasive cleaner is used, as there is the possibility it could scratch the surface.

A protective pad should always be placed under hot utensils.

Sinks

Cleaning can be accomplished using mild liquid detergent with a soft cloth. A complete Home Owners Guide for your sinks is supplied in your Owner's Folder. Please read these instructions before use.

Shower Stall

To clean your fiberglass shower stall unit use warm water and one of the stronger liquid detergents. Do not use abrasive cleaners, they may scratch and dull the surface of your fiberglass unit. Stubborn stains can be removed with solvents such as turpentine, paint thinner or acetone. Restore dulled areas by rubbing with an automotive type liquid cleaner then put the soft glow back into your fiberglass unit with a light application of liquid wax. Chips and gel-coat cracks can be repaired. Check with local repair shops or your dealer for this service.

Dinette

The dinette is made into a bed by rising up on the front of the table and folding the table leg up against the bottom of the leaf. As the table is raised it will unhook from the upper wall brackets. Once it is unhooked it can be pulled out and the wall hinge will let it be lowered on the supports of the dinette seats. The backrests of the seats are placed over the table to complete the conversion.

Rear L-Lounge

The lounge seat has a pull out extension to provide a 48" x 78" bed. There are storage tubs installed under the bed for your convenience.

Metal Interior Skin

The interior shiny metal skin is the same as the exterior coated skin on your trailer. The cleaning and care would be the same. Use common sense on the waxing and washing on the interior. A damp soft cloth will do most of the time.

CAUTION: ABRASIVE POLISHES OR CLEANING SOLVENTS SUCH AS AUTOMATIC DISHWASHER OR ACID ETCH CLEANERS ARE TOO STRONG AND SHOULD NEVER BE USED. RINSE ALL GRIT FROM SURFACE PRIOR TO WASHING. Use soft rags or wash mitts always moving lengthwise with the trailer. NEVER rub hard on the coating. Even the softest rag will damage the coating if excessive pressure is applied.



INTERIOR

Monitor Panel

The monitor panel allows you to check the amount of fluid in your fresh water tank, black water tank, and the gray water tank. The LP gas and battery status are also shown. Further instructions on its use are detailed in the electrical section of this manual.

The MicroPulse Monitor will display the condition of each system at all times. The tri-color LED beside the system will indicate the condition of the system using the following color code.

Fresh Water, LP Gas, Battery are as follows:

Green LED = 3/8 to Full

Yellow LED = 1/4

Red LED = 1/8 to Empty

Gray Water, Black Water are as follows:

Green LED = Empty to 5/8

Yellow LED = 3/4

Red LED = 7/8 to Full

Water Heater Switch

The water heater switch with a red indicator light is for lighting the water heater and is located on the curbside wall above the rear desk on the 22 Ft. model, on the galley wall in the 16 ft, 25 ft. sleep six and 28 Ft. and on the lavatory wall in the 19 ft. model.

Water Pump Switch

The water pump switch is located on monitor panel. Once the switch is turned on, the pump will run until the water pressure reaches about 65 psi. At this point, an internal pressure switch will shut it off. When a faucet is open, the water pressure will drop and the pump will start to run again. The water pump should be turned off when the trailer is left unattended and when city water is being used as the fresh water supply.

Bathroom Exhaust Fan

The bathroom exhaust fan is in the bathroom ceiling and is opened by pushing up on the handle running across the fan opening.

Shower Head

The shower head is designed to give maximum flexibility in usage, and provides for water saving techniques when using your trailer on self-containment. It can be held in the hand and moved about the body. Normally the best water conservation procedure is to wet the entire body and then turn the water off. Apply soap, lather thoroughly, and then rinse the soap off.

Light Switches

Light switches are located throughout the trailer and are labeled for your convenience.

To change the bulb in the round ceiling light, first remove the lens assembly. The lens assembly is spring loaded and pops out of the fixture at its chrome ring. A small screwdriver may be used, be careful not to scratch the chrome and be sure the bulb is cool before attempting replacement. The bulb inserts into the ballast by two wire prongs. Grasp the bulb with a piece of cloth and pull it gently straight out from its ballast. Insert the new bulb, and replace the lens. The lens assembly has two grooves that must be aligned to the light fixture before snapping the lens back into place.

Battery Disconnect Switch

The disconnect switch is used to separate the battery from the 12-volt distribution panel and converter charging system.

When the disconnect switch is turned to **“use”** (on) and the trailer is plugged into a 110-volt shoreline, the 12-volt distribution panel will receive power from the converter as the battery is charged through the converter charging system. If the trailer is not plugged into a 110-volt shoreline, the battery will supply 12-volts to the trailer and no charging to the battery is available since the converter is not receiving 110-volt power.

When the disconnect switch is turned to **“store”** (off) and the trailer is plugged into a 110-volt shoreline, the 12-volt distribution panel will still receive power from the converter, but the battery is disconnected from the system. The battery will not be drained with the switch in the **“store”** position. The converter will not charge the battery with the switch in the **“store”** position either.

The charge in the 12-volt batteries is replenished when towing from the tow vehicle alternator through the 7-way cord. This charge will go to the battery no matter which position the Battery Disconnect Switch is in.

Fresh Air Vents

A control handle operates the ceiling fresh air vents. Turning clockwise will raise the vent. Check your lid gaskets once a year.

Information on the high volume roof vent may be found in the appliance section of this book.

Storage

All cabinets and storage areas should have the heaviest items on the bottom and lighter items overhead. After loading you should have the skillet and can goods on the floor or bottom shelf, and the cereals and crackers in the overhead roof locker. Use the unbreakable type plates and saucers, and consider storing your dish towels around them. Better yet, use paper plates. Who wants to wash dishes when on a trip or vacation?

Clothes hung in wardrobes should be kept on hangers that snap over the clothes rods to keep them from “jumping” off on rough roads. Evening dresses should be kept in the plastic bags like dry cleaning businesses use. No matter how hard you try, if you travel a long dusty section of road the dust will work its way into the trailer and soil clothes. Try to avoid large bulky coats. Layers of lighter clothing will usually keep you warmer, are more versatile and easier to store.



WARNING: Keep flammable material away from the furnace.

Remember, heavy items should be stored low and toward the front, lighter items in the rear and overhead cabinets.

INTERIOR

SMOKE ALARM - FIREX MODEL B

Maple Chase Company
2820 Thatcher Road
Downers Grove, Illinois 60515-4040

IMPORTANT INFORMATION-SMOKE ALARM SAFETY CHECKLIST

1. Test your smoke alarm every week. To test the electronics, firmly depress the button.
To test that smoke reaches the sensor, blow smoke in a careful fire-safe manner into your smoke alarm.
2. Your smoke alarm will not work without power. Never shut off its power or remove the battery to quiet the alarm. FOR BATTERY-POWERED UNITS: When your smoke alarm “beeps” about once a minute, the battery is weak. Immediately install a new battery correctly. Be sure to use only batteries specified in Owner’s Manual or on unit. Test unit after installing a new battery.
3. Clean and vacuum the openings on your smoke alarm once a month.
4. Do not open the smoke alarm or try to repair it. For replacement information see the WARRANTY in the Owner’s Manual.
5. Verify you have the proper number of smoke alarms in your home and the correct location for each one. A smoke alarm will not respond well in an incorrect location.
6. If your smoke alarm has one or more of these special features, please note:
 - FALSE ALARM CONTROL (Model C): Pushing test/hush button reduces sensitivity for up to 15 minutes, minimizing nuisance alarms,
 - FLASHING LIGHT (Model E): Pushing test button turns flashing safety light on. Very thick smoke may obscure light.

7. Smoke alarms have technical limitations and may not respond in all situations. **FIRE PREVENTION** is your best safeguard.

8. For a replacement Owner’s Manual or Safety Checklist, please indicate your unit model, include a self-addressed stamped envelope and send to:

WEEKLY TESTING OF YOUR SMOKE ALARM

1. FOR A COMPLETE WEEKLY TEST OF THE ELECTRONICS AND THE SENSOR OPERATION, FIRMLY DEPRESS THE TEST BUTTON ON THE COVER OF THE SMOKE ALARM FOR A FEW SECONDS. The smoke LED (light emitting diode), which is the indicator light under the clear Push-to-Test button, will blink once per second while the button is being pushed and the alarm is sounding. The smoke alarm will stop sounding when you release the button.
2. If your smoke alarm has the False Alarm Control or Safety Light feature see “SPECIAL SMOKE ALARM FEATURES” for further testing information.
3. **IMPORTANT:** Always test your smoke alarm upon returning from vacation, or any other time when no one has been in your household or residence for several days.
4. If a smoke alarm is installed in a mobile home, test the smoke alarm after you remove the vehicle from storage and before each trip.



WARNING: If your smoke alarm does not respond as described in any of the above tests, check that a good battery is properly installed. If a good battery is properly installed, promptly remove the unit, repack it and return it for repair or replacement.

TAKING CARE OF YOUR SMOKE ALARM

Your smoke alarm has been designed and manufactured to be as maintenance-free as possible. Here are a few simple steps you must perform, in addition to the weekly tests described in the section "WEEKLY TESTING OF YOUR SMOKE ALARM," to keep your unit in good working order.

- The smoke alarm should be vacuumed monthly or more often if there is dust, dirt or kitchen grease that can accumulate. Use a soft brush or wand attachment and vacuum all slots in the cover and side. FOR YOUR SAFETY, you must properly clean and maintain your smoke alarm, since a dirty or malfunctioning unit may fail to alarm or cause unwanted nuisance alarms.
- If the unit is damaged or fails to operate properly, and you have checked that a good battery is installed correctly, follow the directions in the section "WHERE TO SEND YOUR SMOKE ALARM IF IT NEEDS SERVICE" for return. FOR YOUR SAFETY, DO NOT OPEN THE SMOKE ALARM AND TRY TO REPAIR IT YOURSELF. While smoke alarms are economical devices, they contain precision electronic components that are precisely calibrated. The manufacturer must do repairs.

REPLACING THE BATTERY

The smoke alarm will "beep" once a minute for at least 30 days when the battery is weak. The battery must **immediately** be replaced with a fresh one.

The battery should also be changed if it does not sound an alarm when tested. TO REPLACE THE BATTERY:

1. Check if the tamper resist locking pin is installed in the smoke alarm (see "USING THE TAMPER RESIST LOCKING MECHANISM" section). If so, pull the pin completely out of the smoke alarm using long-nose pliers.
2. Remove the smoke alarm from the mounting bracket by twisting counterclockwise
3. Replace old battery with a fresh one. If your smoke alarm has a safety light, the miniature lamp operates on two AA batteries. (See recommended batteries below.)
4. Check that battery connections are secure and the battery is secured in its compartment
5. Test smoke alarm for proper operation (see "WEEKLY TESTING OF YOUR SMOKE ALARM" section). The smoke alarm operates on a 9-volt battery. The normal battery operating life will be one (1) year. The life of some batteries may be less.
6. Firex smoke alarms sold with Ultralife long-life lithium batteries require replacement approximately every ten (10) years or when the low battery signal sounds.

CAUTION: You should only use the batteries specified here or on the label of the unit.

INTERIOR

For Models A, B, C, E and PB use: Eveready 216, 522 or 1222; Mallory MN1604; Duracell MN1604; or Ultralife U9VL-J.

For Model E also use AA Heavy Duty for light power. The miniature lamp operates on two (2) AA batteries. For replacement, use heavy-duty or alkaline AA batteries: Eveready 1215, E91, or Duracell M15HD, MN1500.

CAUTION: Do not use any type of rechargeable batteries.

USING THE TAMPER RESIST LOCKING MECHANISM

To make the smoke alarm somewhat tamper resistant, a “locking pin” has been provided in the base of the unit. It will help deter a child or other individual from removing the smoke alarm from the bracket. See Figure 7. The following directions can install this.

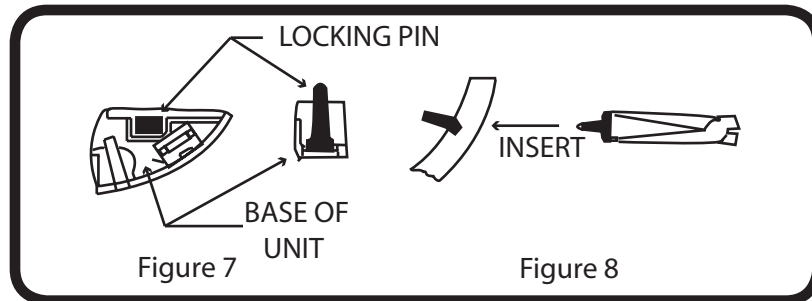

1. Remove the breakaway locking pin from the unit by rocking pin back and forth.
2. Put the smoke alarm back on the mounting bracket. (See section “HOW TO INSTALL YOUR SMOKE ALARM.”)
3. Using long-nose pliers grab the head of the locking pin and insert into hole located on the side of the smoke alarm. See Figure 8.

4. The Tamper Resist feature is now installed and complete.

To Remove:

5. Using long-nose pliers grasp the head of the locking pin and pull the pin completely out of the smoke alarm.
6. The smoke alarm can now be removed from the mounting bracket with a counter-clockwise twist.

SPECIAL SMOKE ALARM FEATURES

If your smoke alarm has one or more of these special features, read the following:

- BLINKING LED LIGHT (Models B, C, E and PB): The indicator light under the Push-to Test button blinks about once per minute to indicate the smoke alarm is receiving power.

 **WARNING:** Very thick smoke may obscure the light.

 **WARNING:** Alarm battery is shipped deactivated. Check your alarm for proper battery installation.

LP GAS DETECTOR

The LP gas detector is located approximately six inches above the floor. LP gas is a mixture of gases produced and sold commercially as a fuel for heating and cooking appliances. LP gas is highly flammable and, as a result, can be explosive if ignited under certain circumstances. LP gas is heavier than air and, if confined in a closed space, will accumulate close to the floor. When the LP gas concentration in your unit exceeds 2000 PPM the detector will provide a visual and audible alarm by sounding a buzzer and flashing the red LED two times per second.



WARNING: Activation of this detector indicates the presence of LP gas, which can cause an explosion and/or fire. This normally indicates a leak in the LP gas installation or a LP gas appliance. Extinguish all open flames, open your windows and door and evacuate the unit immediately. Do not activate any electrical switch. Turn off the LP at your gas bottle(s). **DO NOT RE-ENTER YOUR UNIT UNTIL A QUALIFIED REPAIR TECHNICIAN HAS CORRECTED THE PROBLEM OR A FIRE DEPARTMENT OFFICIAL HAS CLEARED YOUR UNIT AS SAFE.**

OPERATION

Your LP gas detector is wired directly to your vehicle battery and incorporates a 1-amp in-line fuse. When the device is operating normally the green LED will be lit.



WARNING: It is not recommended that the detector be disconnected from the battery during periods of storage. There is a small heater on the sensor of the device, which “burns” away impurities in the air during periods of normal use. During periods when power is interrupted, impurities can build up on the sensor. When power is returned to the detector the detector alarm may activate until the impurities are “burned” off. This could take a number of hours, during which time the alarm will be constantly “on”.

DETECTOR TEST

Press the test button for 5 to 6 seconds until the alarm sounds then release the test button. The red LED should flash and the alarm sound for approximately 4 minutes. This test should be performed at least once a week during normal vehicle operation, and after periods of storage, and before each trip.

LOW VOLTAGE

Below 10 VDC the detector will continue to operate but will blink alternately green and orange. Below 8 VDC the unit will behave erratically and will eventually shut off. To ensure proper operation, do not operate the unit below 10 VDC.

COMPONENT FAILURE

The failure of any circuit component will cause the detector to display a continuous orange LED fault light and a short beep indicating failure. If this occurs, immediately contact your dealer or Airstream Customer Service for the name of the nearest detector service center.

Please read the operating instructions for your detector, which have been supplied with the paper work of your unit.



WARNING: Have a professional check your system if you have any doubts.

INTERIOR

FIRE EXTINGUISHER

The fire extinguisher should have the charge checked on a regular basis. Make sure your family, especially the cook, knows how to release the extinguisher storage bracket, and how to properly operate the extinguisher. If you find the directions on the extinguisher unclear, check with your local fire department for professional advice on its operation and use. We're sure they will be happy to assist you and your family.

SAFETY: Many things can be construed as safety related, but the most important is your common sense. If you are careless with matches, cigarettes, flammable material or any other hazardous material, we are sure you realize your potential for accidents is greatly increased.

EXTERIOR WINDOWS

The windows in your trailer are safety glass. To open: release the two lever locks at the bottom, lift up on the two side operator handles until the window is in the desired position, and place the operators into one of three positioning slots on the side of the frames. To lock the windows, reverse this procedure.



WARNING: The escape window(s) are identified by red release handles and are opened by lifting up both latches, then turning the latches toward the center. Push out on the glass and it will swing clear. The window operation should be checked each trip and the latches lubricated with WD-40 or equivalent every six months. A loop is provided in the SCREEN RETAINING SPLINE so it can be rapidly removed. Take hold of the loop and pull the rubber spline out of the screen frame. The window screen can then be easily pushed out.



WARNING: Check the emergency escape route outside your escape window at every stop. At each campsite make sure you have not parked in such a manner as to block the operation of the escape window by being too close to trees, fences or other impediments. Scenic views are one reason for traveling,

but don't park so the beautiful lake or steep cliff is just outside your escape window. Never park your trailer so the escape windows cannot be easily used for emergency exits.



WARNING: You and all your family should practice escape procedures so they can be rapidly accomplished even in total darkness. Never block the interior or exterior access to the emergency escape windows.

These windows are cleaned in the same manner that ordinary windows are. Clean the seals with a damp cloth or mild detergent every three to six months, taking care not to use a strong solvent, as it will damage the seals. A coat of natural silicone lubricant applied after the seal has dried will keep it flexible. Spread the lubricant evenly with a brush or finger, working it into the surface. This is a good practice for all rubber seals in your Airstream. For replacement of a damaged window contact an Airstream Service Center or the factory.

SCREENS

Your plastic screens are easy to maintain. Just clean them occasionally with a damp cloth.

Note: They will melt at the point of contact if touched by a cigarette.

SATELLITE RADIO (OPTION)

The travel trailer may be equipped with a satellite radio. This system is integrated with the entertainment system on the trailer. The system owner's manual is included with the packet from your dealer.

INVERTOR (option)

The Inverter powers the TV and one additional labeled 110 volt receptacle. The inverter converts 12 volt electricity from your batteries into 110 volt power. The switch for the inverter is located under the monitor panel. Overloading the inverter will cause a automatic shut off to activate. Removing the load will allow the inverter to reset. Monitor battery charge carefully while using the inverter.

APPLE I POD / MP3 INPUT. 12V POWER PORT & RCA JACK CONNECTOR PANEL (option)

A 12 volt port, two RCA jack cords, and a plug in is provided with Audio/Video Upgrade option. These are used to for an Apple Ipod or MP3 player input.

CARBON MONOXIDE ALARM

The following information is highlights from the folder provided by the alarm manufacturer. The folder, with more detailed information, is contained in your Owners' Packet.

CAREFULLY READ AND UNDERSTAND THE COMPLETE CONTENTS OF THE INSTRUCTION MANUAL BEFORE USING THE ALARM.

STORE THE MANUAL IN A SAFE PLACE FOR FUTURE REFERENCE. PAY PARTICULAR ATTENTION TO THE SAFETY WARNINGS. PASS THE MANUAL ONTO ANY SUBSEQUENT USERS OF THE ALARM



WARNING: Activation of your CO alarm's audible horn indicates the presence of carbon monoxide (CO) which can KILL YOU.



WARNING: Alarm battery is shipped deactivated. Check your alarm for proper battery installation.



WARNING: THIS PRODUCT IS INTENDED FOR USE IN ORDINARY INDOOR LOCATIONS OF FAMILY LIVING UNITS. IT IS NOT DESIGNED TO MEASURE COMPLIANCE WITH OCCUPATIONAL SAFETY AND HEALTH ADMINISTRATION (OSHA) COMMERCIAL OR INDUSTRIAL STANDARDS.

INDIVIDUALS WHO ARE AT SPECIAL RISK FROM CARBON MONOXIDE EXPOSURE BY REASON OF AGE, PREGNANCY OR MEDICAL CONDITION MAY CONSIDER USING WARNING DEVICES WHICH PROVIDE AUDIBLE AND VISUAL SIGNALS FOR CARBON MONOXIDE CONCENTRATION UNDER 30 PPM. IF IN DOUBT CONSULT YOUR MEDICAL PRACTITIONER.

INTERIOR

THIS CARBON MONOXIDE ALARM IS NOT

Designed to detect smoke, fire or any gas other than carbon monoxide.

To be seen as a substitute for the proper servicing of fuel-burning appliances.

To be used on an intermittent basis, or as a portable alarm for spillage of combustion products from fuel-burning appliances.

CAUTION: This carbon monoxide alarm is designed for indoor use only. Do not expose to rain or moisture. Do not knock or drop the alarm. Do not open or tamper with the alarm as this could cause malfunction. The alarm will not protect against the risk of carbon monoxide poisoning when the batteries are dead or missing. The alarm will only indicate the presence of carbon monoxide gas at the sensor. Carbon monoxide gas may be present in other areas.

IMPORTANT

Carbon monoxide is produced by the incomplete combustion of fuels such as wood, charcoal, coal, heating oil, paraffin, gasoline, natural gas, propane, butane, etc.

Ideally, it is recommended that a carbon monoxide alarm should be installed in or near every room that has a fuel burning appliance such as any room heaters, water heaters, cookers, grills, etc.

Ensure that the alarm horn can be heard by all those who are intended to hear it. Seek medical help if it is suspected that a user of the RV is suffering from carbon monoxide poisoning.

If the alarm sounds, make sure to investigate the problem. Ignoring the alarm may result in sickness, injury or death. (CO may be present even if nothing is seen or smelled by the user).

Room spaces should be well ventilated when household cleaning supplies are used as these may cause a false alarm.

Alarm should be tested once per week. If further details are required which do not appear in this manual contact BRK Brands Inc. First Alert.

Introduction

This alarm which is designed to detect the presence of carbon monoxide. This manual contains information on operation of the CO alarm. The green light flashes at approximately 60-second intervals to indicate the alarm is operating correctly. The red light will flash continuously and the horn will sound if carbon monoxide is detected. The alarm is suitable for use in areas where cooking and heating appliances burn fuels such as wood, charcoal, coal, oil, gas, etc.

This carbon monoxide alarm is designed to detect carbon monoxide gas from any source of combustion

WHAT IS CARBON MONOXIDE

Carbon monoxide (CO) is a highly poisonous gas which is released when fuels are burnt. It is invisible, has no smell and is therefore very difficult to detect with the human senses. Under normal conditions, in a room where fuel burning appliances are well maintained and correctly ventilated, the amount of carbon monoxide released into the room by appliances is not dangerous.

These fuels include: Wood, coal, charcoal, oil, natural gas, gasoline, kerosene, and propane.

Common appliances are often sources of CO. If they are not properly maintained, are improperly ventilated, or malfunction, CO levels can rise quickly. CO is a real danger in "Air-tight" RVs with added insulation, sealed windows, and other weatherproofing can "trap" CO inside.

The following conditions can result in potentially dangerous CO situations.

1. Excessive spillage or reverse venting of fuel burning appliances caused by outdoor conditions, such as:

Wind direction and/or velocity: including high gusts of wind. Heavy air in the vent pipes (cold/humid air with extended periods between cycles).

Negative pressure differential resulting from use of exhaust fans.

Simultaneous operation of several fuel burning appliances competing for limited internal air.

Vent pipe connections vibrating loose from clothes dryers, furnaces or water heaters.

Obstructions in or unconventional vent pipe designs which can amplify the above situations.

2. Extended use of un-vented fuel burning devices.

3. Temperature increase that can trap exhaust gases near the ground.

SYMPTOMS OF CARBON MONOXIDE POISONING.

These symptoms are related to CO POISONING and should be discussed with users of the RV.

Mild Exposure - Slight headache, nausea, vomiting, fatigue, ("flu-like" symptoms),

Medium Exposure - Throbbing headache, drowsiness, confusion, fast heart rate.

Extreme Exposure - Convulsions, unconsciousness, heart and lung failure,

Exposure to carbon monoxide can cause brain damage, death.



WARNING! Many causes of reported CARBON MONOXIDE POISONING indicate that while victims are aware that they are not well, they become so disoriented that they are unable to save themselves by either exiting the building or calling for assistance. Also young children and pets may be the first to be affected.



PLUMBING

LIQUID PETROLEUM GAS (LPG)

FILL VALVE

Your trailer is equipped with LP tank fill valves called “RV Type I Acme” connection. The large, green, nylon swivel nut is a right hand thread and is designed for hand operation only.

The valve features an internal spring-loaded module that will not allow gas to flow from the cylinder until a positive seal has been made at the connection. The valve outlet has 1-5/16” Acme threads on the outlet exterior and female POL, left-handed threads on its interior. This feature allows for connection of the new wrenchless, right-handed, Acme RV connection and still accommodates the standard left-handed POL fittings used for filling propane cylinders.

The mating, green swivel nut and brass nipple also incorporates new features: the green nylon nut swivels on a black bushing that is heat sensitive. Between 240 degrees F and 300 degrees F the bushing will yield (melt) allowing the spring-loaded module in the valve to push the brass nipple back (approximately 1/4”) closing the module and stopping the flow of gas from the cylinder. Inside the brass nipple is a flow-limiting device designed to sense excessive gas flow. If an excessive flow is sensed, the flow-limiting device shuts the flow down to a maximum of 10 SCFH (Standard Cubic Feet per Hour) or less. This is also referred to as the by-pass flow.

By-pass flow is extremely important in the proper operation of this connection. The flow-limiting device may activate if the cylinder valve is opened quickly. When all appliances are off, the by-pass flow allows the pressure downstream from the flow-limiting device to equalize. When pressure is equalized, the flow-limiting device will supply normal flow to the system. Equalization occurs in approximately 5 seconds and in most cases goes completely unnoticed. If, however, an appliance is left on or there is a leak or open flow in the system, the by-pass pressure will not be able to equalize and allow the flow-limiting device to re-open. Symptoms of this condition would be

appliances that light but have lower than normal flame or starve out from lack of gas, a substantial reduction in the flame when another appliance is operating, or pilots that are difficult to light. If this should happen, the following steps should eliminate the condition:

1. Close LP cylinder valve.
2. Extinguish all flames and smoking materials
3. Be sure all gas appliances, including their pilot lights, are off.
4. Open LP cylinder valve slowly. DO NOT SNAP OPEN.
5. Wait at least 15 seconds before lighting appliances.
6. If operational difficulties continue, there may be a leak in the system. Immediately close the LP cylinder valve and have the system inspected by a qualified RV service technician.

Again, make sure all appliances are off before opening propane cylinder valves. Exception: when reconnecting a full cylinder to an auto changeover regulator it is not necessary to shut off the appliances or close the valve of the cylinder already in service.



WARNING: LEAKING LP GAS MAY IGNITE CAUSING A FIRE OR EXPLOSION WHICH COULD RESULT IN SERIOUS BODILY INJURY, PROPERTY DAMAGE, OR DEATH.

How long a full tank of gas will last is dependent on usage. In cold weather, when you are using the furnace, large amounts of hot water, and are doing extensive cooking, you will naturally use more than you will in warm weather when you may do limited cooking. On the average, with normal cooking and other appliance use you can probably count on two to three weeks of service from each tank.

AUTOMATIC GAS REGULATOR

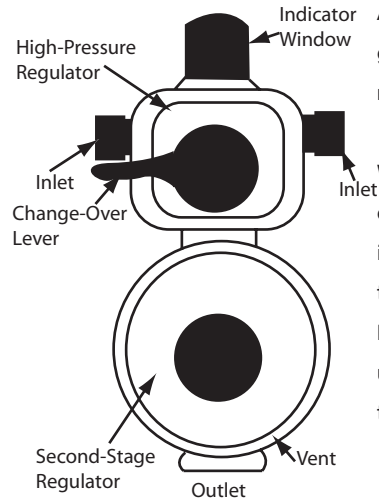

All models are equipped with an automatic gas regulator. Both tanks are connected to this regulator.

When the gas is turned on it is drawn from only one tank at a time. When the tank being used is depleted the regulator automatically switches to the full tank. An indicator in the regulator knob points toward the tank that was being used to give you a visual reminder when one tank is empty.

Operation

Make sure there is propane in both cylinders before you start. Rotate the black lever on the top front side of the regulator toward the cylinder you want to use first. This will be the “service” cylinder and the other will be the “reserve” cylinder. Slowly open both tank valves completely, then close about 1/4 turn. This will allow you to easily check to see if valves are open or closed. The indicator on the top of the regulator will turn bright green. The indicator color will stay green as long as there is fuel coming from the service side. When the service cylinder empties, the regulator will start drawing from the reserve cylinder providing an uninterrupted fuel flow to the system. When it switches over, the indicator color changes from green to red. This red color indicates that the service cylinder is empty and needs to be filled.

Now disconnect the cylinder and have it refilled. After filling, reconnect the pig- tail and slowly open the cylinder valve. The full cylinder now becomes the reserve.

LPG BOTTLES

The following step-by-step procedure gives you the proper method of removing and installing these bottles:

1. Rotate the black lever all the way over towards the reserve cylinder. The indicator will turn green and the reserve cylinder becomes the service cylinder. Now shut off the cylinder valve on the empty cylinder.
2. Disconnect the green swivel nut from the cylinder valve at the bottle to be removed. (This fitting has a common right hand thread and turns in the same direction to most threaded fittings.)
3. Turn the large clamping “T” handle counterclockwise until the hold down bracket is loose enough to remove the bottle. If your trailer is equipped with a gas bottle cover the “T” handle must be removed, and then remove the cover before removing the bottle.

DO NOT REMOVE THE CENTER HOLD DOWN ROD!

To Install

1. Place the bottle in position on the “A” frame and bottle cross member so that it rests on the upper collar of both bottles with the collar rims engaged in the grooves on the underside of the bracket. If your trailer is equipped with a gas bottle cover it should be positioned over the bottles next. Make sure the hold down rod projects up through the hole in the shroud center bracket.
2. Replace the “T” handle and tighten down until the bottles are held firmly in place.
3. Hand-tighten the green nylon swivel nut onto the tank valve outlet.
4. Turn on gas shut off valves and test all fittings with a soap suds or detergent solution and watch for bubbles.

PLUMBING

LIQUID PETROLEUM GAS (LPG)

 **WARNING:** LP gas regulators must always be installed with the diaphragm vent facing downward. Regulators that are not in compartments have been equipped with a protective cover. Make sure that regulator vent faces downward and that cover is kept in place to minimize vent blockage, which could result in excessive gas pressure causing fire or explosion.

CAUTION: The LPG bottles are securely mounted on the front “A” frame of your trailer. If these bottles must be removed for service or replacement it is important that they be reinstalled correctly in order to prevent any possibility of their falling off or becoming dislodged during travel.

 **WARNING:** Your LP tanks must be filled as directed by the tank manufacturer. Instructions are located on a decal near the fill valve. The decal must not be defaced.

 **WARNING:** Your LP tank must be, and can only be, placed in the proper position when remounting on the front of the trailer. In any other position the base of the tank will not fit into the recess.

 **WARNING:** Use only the gas bottles furnished with your trailer. If replacement is required it must be a bottle of the same size and design.

 **WARNING:** The vent at the bottom of the regulator must be kept free of any obstructions and must be pointed downward. A good habit is to check the vent each time a bottle is removed for filling. It is especially important to check the vent if the trailer has not been used regularly.

Twice a year, or after a long storage period, we suggest you take your unit in for a checkup and cleaning of the gas operated appliances.

LIQUID PETROLEUM GAS (LPG)

BASIC RULES FOR SAFETY

 **WARNING:** Do not store LP containers within a vehicle. LP containers are equipped with safety devices that vent gas should the pressure become excessive.

 **WARNING:** Do not use cooking appliances for comfort heating. Cooking appliances need fresh air for safe operation. Before operation open an overhead vent or turn on an exhaust fan and open a window.

A warning label has been located in the cooking area to remind you to provide an adequate supply of fresh air for combustion. Unlike homes, the amount of oxygen supply is limited due to the size of the recreational vehicle; and, proper ventilation when using the cooking appliances will avoid dangers of asphyxiation. It is especially important that cooking appliances not be used for comfort heating as the danger of asphyxiation is greater when the appliance is used for long periods of time.

 **WARNING:** Portable fuel burning equipment, including wood and charcoal grills and stoves, shall not be used inside the recreational vehicle. The use of this equipment inside the recreational vehicle may cause fires or asphyxiation.

 **WARNING:** A warning label has been located near the LP gas container. This label reads: **DO NOT FILL CONTAINER (S) TO MORE THAN 80 PERCENT OF CAPACITY.**

Overfilling the LP gas container can result in uncontrolled gas flow, which can cause fire or explosion. A properly filled container will contain approximately 80 percent of its volume as liquid LP gas.

 **WARNING:** Do not bring or store LP gas containers, gasoline or other flammable liquids inside the vehicle because a fire or explosion may result.

 **WARNING:** IF YOU SMELL GAS:

1. Extinguish any open flames, pilot lights and all smoking materials.
2. Do not touch electrical switches.
3. Shut off the gas supply at the tank valve(s) or gas supply connection
4. Open doors and other ventilating openings.
5. Leave the area until odor clears.
6. Have the gas system checked and leakage source corrected before using again.



PLUMBING

WATER SYSTEM-SELF CONTAINED

Fill the water tank by opening the exterior access door and remove screw cap. A garden hose can now be inserted. It's a good idea to let the water run through the hose for a short time to flush it out. Experienced RVers usually fill their tanks with "home" water to avoid strange water that may be distasteful to them.

The amount of water in the tank may be checked on the Monitor Panel, or you may fill the tank until water overflows out of the fill.

Open the hot side of the galley or lavatory faucet and turn on the water pump switch located on the monitor panel. For some time the open faucet will only sputter. This is because the water heater is being filled and air is being pushed out through the lines.

Once the water heater is full, a steady stream of water will come from the faucet. Now open a cold faucet. It will sputter for a short time, but will soon expel a steady stream. All other faucets can now be opened until all air is expelled.

Once the system is filled with water and the faucets closed, the water pump will shut off. When a faucet is opened the pump will come back on automatically. If the faucet is just barely open it is normal for the pump to cycle on and off rapidly.

CAUTION: The water pump must be turned off when hooked up to city water supply and when you leave your Airstream unattended.

WATER PUMP AND STRAINER

Water pump and strainer are located under the roadside dinette seat. Lift cushion to reveal access panel.

To clean strainer screen, first remove inlet connection from the pump side of strainer. This will allow the intake side of the strainer to be rotated about 1/8 turn counter clockwise and be removed. The screen part of the strainer will now be accessible for cleaning.

When reassembling only rotate the inlet side of the strainer until the stops are felt. The "O" ring performs sealing and too much pressure will only break the strainer.

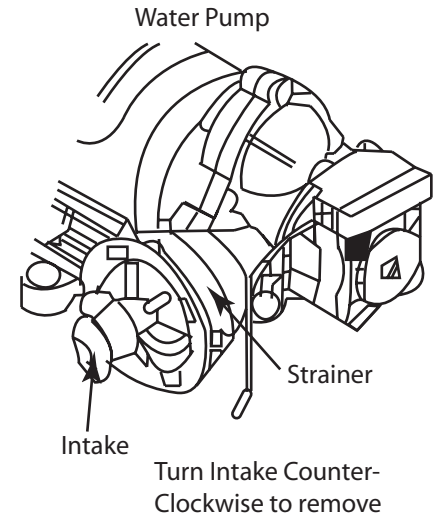

LUBRICATION

If the lubricant appears dried out it should be wiped off the bearing assemblies. A small amount of automotive wheel bearing grease should be applied to both sides of each bearing.

CAUTION: Do not remove the stainless steel screens. These filter screens should be cleaned without removing them from the plastic housing.

FRESH WATER TANK SANITIZING

Potable water systems require periodic maintenance to deliver a consistent flow of fresh water. Depending on use and the environment the system is subject to, sanitizing is recommended prior to storing and before using the water system after a period of storage. Systems with new components, or ones that have been subjected to contamination, should also be disinfected as follows:

1. Use one of the following methods to determine the amount of common household bleach needed to sanitize the tank.
 - A) Multiply “gallons of tank capacity” by 0.13; the result is the ounces of bleach needed to sanitize the tank.
 - B) Multiply “Liters of tank capacity” by 1.0; the result is the milliliters of bleach needed to sanitize the tank.
2. Mix into solution the proper amount of bleach within a container of water.
3. Pour the solution (water/bleach) into the tank and fill the tank with potable water.
4. Open all faucets (Hot & Cold) allowing the water to run until the distinct odor of chlorine is detected.
5. The standard solution must have four (4) hours of contact time to disinfect completely. If you double the solution, this concentration allows for contact time of one (1) hour.
6. When the contact time is completed, drain the tank. Refill with potable water and purge the plumbing of all sanitizing solution.

Note: The sanitizing procedure outlined above is in conformance with the approved procedures of RVIA ANSI A119.2 and the U.S. Public Health Service.

Note: Two pet cocks, located on the tank pans under the trailer just in front of the wheels on the roadside are the low point drains for the hot and cold water lines. A large valve located on the side of the tank pan on the 22 ft, 25 ft, and 28 ft. will drain the fresh water tank sufficiently for most purposes. The 16 ft. and 19 ft. fresh water tank drain valve is located under the roadside dinette beside the water tank.



PLUMBING

CITY WATER HOOK-UP

The city water hook-up is found on the side of the trailer.

Use a high-pressure hose of at least 1/2" diameter. It should be one that is tasteless, odorless and non-toxic designed for RV use. The city water inlet is a standard garden hose thread. We suggest you carry two lengths of hose. This way you have the ability to reach hookups further away than normal, plus you have a spare hose should one fail or become damaged unexpectedly.

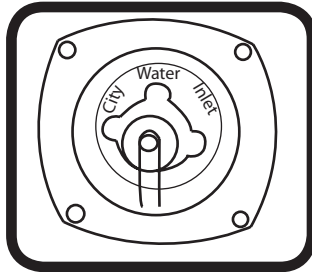

After hooking up the hose and turning on the city water valve provided in the park, slowly open a faucet. There will be a lot of spurts and sputtering until all the air is expelled from the trailer system. If the water heater and fresh water lines are empty it will take some time before all the air is expelled and you get a steady flow of water at the faucet. Once a steady flow is achieved at one faucet the others should be opened long enough to expel the air in the lines going to them.

CAUTION: Hydrogen gas can be produced in a hot water system served by this heater that has not been used for a long period of time (generally two weeks or more). Hydrogen gas is extremely flammable. To reduce the risk of injury under these conditions, it is recommended that the hot water faucet be opened for several minutes at the kitchen sink before using any electrical appliance connected to the hot water system. If hydrogen is present there will probably be an unusual sound such as air escaping through the pipe as the water begins to flow. There should be no smoking or open flame near the faucet at the time it is open.

Your plumbing system has a built in pressure regulator to protect your lines and faucets from extremely high pressures on some city water systems.

GALLEY FAUCET

MODEL 67315C

Manufacturer:

United States

Moen Incorporated

25300 Al Moen Drive

North Olmstead, OH. 44070-8022

www.moen.com

Canada

Moen Inc.

2816 Bristol Circle

Oakville, Ontario L6H5s7

For US customer service, warranty, and a local parts outlets contact Moen at 1-800-BUY-MOEN (289-6636).

For Canadian service contact: Toronto 905-829-3400,
Rest of Canada 1-800-465-6130

Care Instructions

As with any fine polished surface, your faucet will retain its shine for years to come with proper care. The LifeShine™ finish on the faucet does not require the extraordinary work needed to maintain most fine polished brass finishes.

Be sure to read and follow usage instructions enclosed any scour pad or scrub sponge before use.

- **CAUTION:** Do not use pads or sponges that specifically do not recommend use for cleaning polished services.
- **CAUTION:** Many pads or sponges with green fibrous surface (such as Scotch-Brite™ heavy duty scrub sponges) contain microscopic mineral particles that can scratch nearly all polished services, including this faucet finish.

The LifeShine™ finish can be cleaned with most household cleaners (including mild abrasives), when used according to their manufacturers instructions for use.

- Rinse any strong cleaners off immediately after used to maintain the LifeShine™ finish luster.

Mild scrubbing with fine steel wool (0000 grade) can remove build up dirt or water stains.

Visible water spots on this highly lustrous and reflective finish can be easily wiped off with a cloth dampened with water or with glass cleaner.



PLUMBING

DRAIN VALVES

The hot and cold low point water line drain valves are located in two different places.

Two are located under the rear bed and access has been provided in the bed top under the mattress. (If you are long and lanky, they can be reached through the exterior storage compartment.) The other two line drain valves are located under the roadside dinette seat. Remove the cushions to access a removable panel in the lounge top.

Open these low points drain valves and use the hitch jack to raise and lower the trailer front end to drain the water out of the hot and cold water lines.

To Empty Fresh Water Tank

The water tank drain valve is located under the roadside dinette seat; remove the cushions to access panel. Pumping the water out with the self-contained water pump also empties the fresh water tank. Simply turn on the pump switch and open a couple of faucets until the water will no longer comes out.

Note: For winterizing purposes, only the large tank drain valve needs to be opened to drain the fresh water tank.

Water Heater Draining

The water heater has a drain plug or petcock. Access is from the exterior. The plug or valve is usually located in the lower left corner, viewed as you face the exterior of the water heater.

TOILET SHUTOFF VALVE

Your Airstream has one other water shutoff valve. It is located behind the toilet and used to shut water off to the toilet in an emergency or service situation.

WINTERIZING AND STORAGE

When storing your trailer for short or long periods use the same precautions as you would in your own home in regard to perishables, ventilation and rain protection. In addition, for prolonged storage periods flush out all the drain lines and the holding tanks. Also drain the entire water system including the water heater and the water storage tank. Instructions for draining the water system are explained in the following paragraphs on winterizing.

THE MAIN CONSIDERATION IN WINTERIZING IS TO GUARD AGAINST FREEZING DAMAGE TO THE HOT AND COLD WATER SYSTEMS, THE WASTE DRAIN SYSTEM (INCLUDING THE TRAPS), AND THE WATER HOLDING TANKS, THE WATER HEATER, AND THE BATTERY.

To completely winterize your trailer follow this procedure.

1. Level the trailer from side to side and front to rear. Open all faucets
2. Turn the water pump switch to the ON position to expel water from the storage tank or open the fresh water tank drain valve.
3. Open all low point water drain valves including drain plug or valve on water heater (See drain valves on previous page).
4. While the water is draining from the system, open and flush the toilet-flushing valve. Depress hand spray lever while holding the spray head down inside the bowl. Depress hand spray thumb button on the telephone shower head while holding down inside the tub and drain all water from the flexible hose. Unscrew the heads on both spray units and store.

5. Turn the pump switch OFF after all water has been removed from the storage tank.
 6. Remove outlet hose from water pump.
 7. Disconnect the water pump inlet connection and turn the pump on until all the water is expelled. This water, about ½ cup, can be caught in a towel or rag.
 8. Lower the front of the trailer as far as the jack will allow until water ceases to drain, then raise the jack up as high as it will go and let any remaining water drain out.
 9. After the water has stopped running from the drain lines, apply at least 60 lbs, of air pressure at the city water inlet. An air to city water adapter is available from your dealer's RV accessory store. Be sure the toilet valve and all drain valves and faucets are open and pump outlet hose is disconnected. This can be accomplished at a service station and will force any remaining water from the water heater and remove any water which may be trapped in low areas.
 10. Pour a cup of *approved non-toxic RV antifreeze into the lavatory, sink and tub drains to prevent trap freeze-up.
- *Approved and listed by a recognized testing authority such as UL (Underwriter Lab).
11. Be sure to open the waste holding tank drain valves and drain and flush the tanks thoroughly (THIS IS VERY IMPORTANT AS THE SEWAGE IN THE TANKS, IF FROZEN, COULD SERIOUSLY DAMAGE THE TANKS.)
 12. Remove the cartridge of the water purifier and leave the purifier valve in the open position. (If so equipped.)
 13. Remove the battery from your trailer and store in a cool dry place where there is no danger of freezing. It is very important for optimum life of a battery to check it periodically and to keep it fully charged.



PLUMBING

14. Remove any items (food, cosmetics, etc.) from trailer interior that might be damaged by freezing - or might damage the trailer if containers break.

For additional winterizing protection add a non-toxic antifreeze (approved for drinking water system) to the water lines using the following procedure.

1. Reconnect all lines except the hose to the pump inlet port. Close all drain valves.
2. Turn water heater by-pass valves to the by-pass position. See Shut off Valves explanation in this section.
3. Attach a length of hose to the pump inlet port. This piece of hose should be long enough for the free end to be inserted into and reach the bottom of the antifreeze container.
4. Dilute the antifreeze solution in accordance with the manufacturer's instructions.
5. Open all water faucets.
6. Insert hose length into the antifreeze container, turn the pump switch on, and run the water pump until the antifreeze solution fills all water lines. Flush toilet. Work hand shower spray while holding down in tub.
7. Shut off the pump and close all faucets.
8. Disconnect the hose length from pump inlet fitting and reconnect water system inlet line.

Water heater by-pass valves location is under the bed on the roadside through a hole cut in the bed top.

Normal flow position is: shut off valve B - open valves A and C. In some models the valves may be in a horizontal pattern or on top of the heater, rather than the vertical shown in the illustration. Valve operating sequence will be the same. Open valve B and close valves A and C to by-pass filling the water heater for winterizing. Valves may be on top of water heater

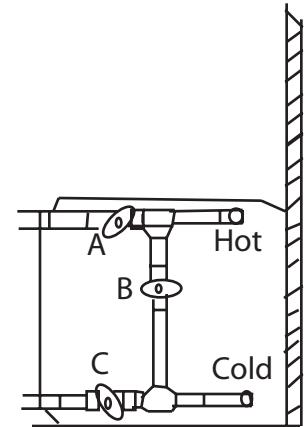
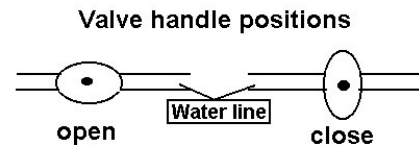

DRAIN AND WASTE SYSTEM

Your trailer has a drain and waste system that includes waste-holding tanks made from molded plastic, free from corrosion problems, with trouble-free dump valves.

The MAIN (BLACK) HOLDING TANK enables you to use the toilet for several days away from disposal facilities. The wastewater from the sink, shower, bath and lavatory drains in the AUXILIARY (GRAY) HOLDING TANK. Each tank has its own dump valve, however, both tanks drain through a common outlet. Therefore, you need to make only one connection when hooking up in a trailer park with sewer facilities.

CAUTION: Never put wet strength paper towels or tissues in your holding tank since they won't dissolve and can "catch" in the mechanism of the dump valve. Colored toilet tissue is slower to dissolve than white. Most RV accessory stores offer tissue designed for RVs that will completely dissolve.

Deodorizers

There are many deodorizers on the market in tablet, liquid and powder form. These not only combat odor, but also stimulate the bacteria that works to dissolve the solids in your tank.

Monitor Panel

Check your monitor panel frequently. When the MAIN HOLDING TANK, (BLACK) is completely full, sewage cannot be emptied from the toilet bowl. If the AUXILIARY HOLDING TANK (GREY) is overfilled, drain water will "backup" into the tub and cause an unpleasant cleaning job. Never drain the tanks at any place other than an approved dumping station. For complete instructions on this panel see section G.

Emptying Tanks

Almost all campgrounds will have dumping facilities. Park directories such as Woodalls and Rand McNally also list dumping stations.

To empty one or both tanks attach the sewer hose by pressing the bayonet fitting onto the dump valve outlet and rotate clockwise until it feels solid and secure. Attach the outlet end of the hose to the sewage outlet; making sure that the hose is placed so it will drain completely.

Pull the dump valve handle as far as it will go and wait until the tank is drained. When dumping, the main holding tank should be dumped first; then the auxiliary holding tank. This will help to rinse out the sewer line with auxiliary holding tank water.

The main holding tank must be flushed out until all paper and waste material is removed. Close the dump valve and refill the tank with clean water and repeat until clean. Replace the cap prior to traveling.



PLUMBING

When Parked and Connected to Sewer Outlet

When you are in a park and connected to a sewer outlet keep the main holding tank dump valve closed, and empty the tank every few days or whenever it becomes almost full. ONLY BY SENDING A LARGE VOLUME OF LIQUID THROUGH THE MAIN HOLDING TANK AT A TIME WILL TOILET PAPER AND OTHER SOLIDS COMPLETELY WASH AWAY.

This practice will avoid the accumulation of solids in the main holding tank, which could lead to an unpleasant cleaning job. Should solids accumulate, close the dump valve; fill the tank about half full with water, then tow the trailer for a few miles. The turbulence and surging of the water will usually dissolve the solids into suspension so the tank can be drained. Keep the auxiliary tank valve open when connected to a sewer outlet.

Draining the tanks as described will protect them from freezing during storage. When traveling in sub-freezing temperatures use a winterizing solution designed for RV use. Follow the directions on the container.

Drain Systems Cleaning

The only cleaning agents that can be used without causing harm to the system are household ammonia and tri-sodium phosphate in small quantities. Do not use any product that contains any portion of petroleum distillates. This attacks the rubber seats of your toilet and dump valve. Also, do not use any dish detergent or abrasive cleaners. All products should be marked approved for ABS drainage systems.

When winterizing drains use only trailer plumbing system type antifreeze. These are sold through your dealer.

BLACK TANK FLUSH

This trailer model has a water hose connector marked "black tank flush". To use, hook up a hose and turn on full force. Within the tank a spray head with a multiple holed head will spray the interior surface of the tank. The vacuum breaker and check valve will be located inside the trailer above the exterior connection.

The gate valve should be closed for the first couple of minutes, and then opened to let the water out in a rush. Repeat as needed.

TOILET

Manufacturer: Sealand Technology
13128 State Route 226
P.O. Box 38
Big Prairie, Ohio. 44611
Phone: 1-800-321-9866

The RV toilet in your Airstream is a design that has been used for many years.

In normal use simply depress the pedal and this dumps the sewage while fresh water flushes down the side of the bowl. Water will continue to run into the bowl for a short time after the pedal is released.

CAUTION: When you dump the bowl of the toilet make sure all paper and solids have cleared the mechanism before you allow it to close. Failure to do so can cause the mechanism to become jammed and it will no longer close completely.

The Owner's Manual supplied with the toilet has several maintenance and cleaning instructions. Please read and follow all instructions.



ELECTRICAL SYSTEM

12 VOLT OPERATION

The major portion of electrical power in your Airstream is 12-volt. The 12-volt current powers the fans, furnaces, water pump, and water heater ignition. The exception would be the air conditioner and microwave oven.

All 12-volt current comes through the battery system in the front of your trailer. The battery is accessible in the battery box on the A-frame of your trailer. Power from the battery goes to a set of four Type 2 thermal breakers located under the front bed and riveted to the inside skin front plate. The breakers are tied together by a brass bus bar. One breaker (30 Amp.) protects the 12-volt tow vehicle charge line coming from the 7-way cord. Another breaker (20 Amp.) feeds the trailer brakes breakaway switch located near the hitch coupler. A 50 amp. breaker feeds the Battery Disconnect relay. The current leaves the relay and goes to the 12-volt distribution panel located in the converter and then to the rest of the trailer. Open the brown decorative door on the front of the converter under the dinette to access the panel and its fuses. A 12-volt layout diagram is shown later in this section.

BATTERY DISCONNECT SWITCH

The disconnect switch is used to separate the battery from the 12-volt distribution panel and converter charging system.

When the switch is turned **“use”** (on) and the trailer is plugged into a 110-volt shoreline, the 12-volt distribution panel will receive power from the converter and the battery will be charged through the converter charging system.

When the switch is turned to **“store”** (off) and the trailer is plugged into a 110-volt shoreline, the 12-volt distribution panel will still receive power from the converter, but the battery is disconnected from the system. The battery will not be drained with the switch in the store position. The converter will not charge the battery with the switch in this position.

The charge in the 12-volt batteries is replenished when towing from the tow vehicle alternator through the 7-way cord. This charge will go to the battery no matter which position the Battery Disconnect Switch is in.

ELECTRICAL SYSTEM

BATTERY



WARNING: Before inspecting or servicing storage battery, read and follow battery manufacturers cautions and directions.

CAUTION: A normal battery can discharge by itself in 30 to 40 days when not in use, therefore, IT IS NECESSARY TO PERIODICALLY CHECK THE BATTERY AND CHARGE IT AS IS NECESSARY.

We suggest checking the battery at least every two weeks in freezing weather. The temperature at which a battery will freeze depends on the condition of its charge. As an example: a fully charged battery with a specific gravity of 1.265 will not freeze until the electrolyte temperature drops to - 71.3 degrees F, while a discharged battery will freeze at +19 degrees F. The following table shows the freezing points of batteries at various specific gravity readings, temperature corrected 80 degrees F.

1.265	-71.3 F
1.250	-62 F
1.200	-16 F
1.100	+5 F
1.150	+19 F

Do not add water to a battery in freezing temperatures unless the vehicle will be put to use at once, otherwise the added water may freeze. Neglect is expensive. Care costs little. Check your batteries regularly.

MAINTAIN A CLEAN BATTERY TOP AND CHECK TERMINALS AND CABLES FOR TIGHTNESS AND CLEANLINESS. A dirty battery will dissipate its charge through surface contamination. Clean battery top with a damp cloth and dry thoroughly.

The terminals should be tight and free of corrosion. To clean terminals, neutralize with a solution of baking soda, rinse in clear water, and dry.

Note: Care must be used to make sure soda is not allowed to enter battery cells.

To insure maximum battery capacity on the charge and the discharge, the battery terminals and the inside portion of the cable connector should be scraped or brushed until both of these surfaces are shiny bright. The cable connectors should then be reconnected to the battery and tightened. The complete assembly, battery post and cable connector should be coated with heavy body mineral grease, petroleum grease or petroleum jell.

CAUTION: RECONNECT THE BATTERY CABLES TO THE CORRECT BATTERY POSTS. The black cable should be connected to the negative (-) post and the red cable to the (+) post. The polarity of your tow vehicle must also be negative (-) ground since it must always match the trailer. Most tow vehicles are negative grounded, but always check your vehicle owner's manual to be sure.

ADD WATER TO CELLS AS NECESSARY. Check the electrolyte level at least once a month. When you are traveling steadily and for an extended period of time, or if you are in climates above 90 degrees F, check the electrolyte level about every two weeks.

CAUTION: Do not fill battery above the split ring in filler opening. DO NOT MEASURE SPECIFIC GRAVITY IMMEDIATELY after adding water. The water must mix with the electrolyte by charging or by driving a few miles.



ELECTRICAL SYSTEM

Some situations, which may indicate a need for battery replacement, are:

1. Loss of more water in one cell than others.
2. Continuous loss of water in all cells—perhaps accompanied by overheating or extreme gassing and bubbling.
3. A marked difference in the specific gravity reading between cells.



WARNING: The gases generated within a storage battery cell may be ignited by an open flame or spark in the vicinity of the battery. Do not use a match or flame to provide light for checking the level of the water.

During the winter the battery should be removed from the trailer and stored in a cool, dry place, where there is no danger of freezing. It should be kept full of water, cleaned and charged monthly. A battery that is allowed to completely lose its charge will never regain its original power or a full charge.

Remove the battery from its container.

For battery service or replacement, go to any service station or dealer who sells and services the make battery installed in your trailer.

When being towed, the 12-volt battery in your trailer is receiving a constant charge from the vehicle's generator or alternator through the seven-way connector.

Your tow vehicle's voltage regulator controls the charge rate. It is important to keep the seven-way connector clean. One method is to use "Spra-Kleen".

Whenever possible use the automatic built in charge of the converter system for charging. The charging circuit automatically controls the current, reducing it as the battery increases in charge.

At service stations make certain they give your battery a slow charge because quick charges will drastically shorten the life of the battery, as will allowing repeated complete discharges.

POWER CENTER (Converter, 12-Volt Distribution, 110-Volt Distribution) MagneTec 7355

Manufacturer:

MagneTec
102 North Main Street
Goodland, Indiana 47948
Phone: (800) 443 4859
Fax: (219) 297 2305

The converter/charging system is the interior low voltage electrical system that enables you to use the interior lights, fans, pumps and 12-volt appliances whether operating on self-contained battery power or 120-volt city power. The 12-volt light bulbs give off the same light as regular household bulbs, so that when operating on self-contained battery power, everything works normally except the 110-volt convenience outlets and 110-volt appliances. The converter system is designed to maintain constant output voltages regardless of the variances that occur in city power systems.

ELECTRICAL SYSTEM

12V POWER CIRCUITS

The current in the converter system is 12 volts direct current (12VDC) negative grounded.

Power sources that supply 12VDC current to the system are as follows:

- A. Main charge line from tow vehicle
- B. Trailer Battery
- C. Converter

The power sources above are all electrically connected to the 12-volt distribution fuse panel that distributes current to interior branch circuits. The circuits provide power to operate all 12-volt DC lights, pumps, motors and appliances.

The 7300 series power converter is a solid-state electronic power supply and is maintenance free. It is so self-sufficient and quiet that you will probably not know it is working except for the fact that your batteries are always charged, and your 12-volt lights and appliances always work. If any 12-volt appliance fails to operate, first check your recreational vehicles 12-volt distribution fuse block located behind the decorative front door in the front right hand corner of the converter and inspect all fuses. If a fuse is opened or blown replace it with the same size fuse (never install a larger use). If the fuse opens again, have an electrician or certified RV technician locate the circuit trouble. Replace blown fuses with Littelfuse type 257 fuses only.

If the 7300 series power converter is not working, first confirm the RV supply or shore-line cord is plugged into a live circuit. Then check all the 120-volt breakers in your RV distribution panel to make sure they are on. If the breaker is tripped, follow the instructions to reset the breakers. If the breaker trips again, consult an electrician or certified RV technician.

CONVERTER OPERATION

The MagneTec 7300 series electronic power converter is designed to supply the nominal 12-volt filtered D.C. power for all 12 volt operated devices encountered in RV service. Although the converter is an excellent battery charger, the converter does not require a battery to be connected to it for proper operation.

CAUTION: When installing a battery (s) always observe polarity. Connecting a battery reverse polarity will blow the power converter main fuses located on the 12 volt D.C. distribution fuse block.

120 VOLT AC PANEL BOARD

The AC panel board section of the series 7300 is located behind the decorative door in the upper left-hand corner. This panel contains the 120 Vac branch circuit breakers for your RV. One of the breakers controls the 120 volt power to the 12 volt converter section located in the lower half of the 7300. This breaker may also control another branch circuit. Check the label next to each breaker for what each branch circuit breaker controls.

The 120 volt circuits may be turned “on” by putting their breaker handle up to the on position or “off” by flipping the handle down to the off position. To reset the tripped breaker move handle to off then on.

CONVERTER COOLING SYSTEM

The 7300 electronic fan cooling system is the key to long life and trouble-free operation. The fan is never on more than required to cool electronic components in the converter. You may never hear the fan operate.



ELECTRICAL SYSTEM

12-VOLT INTERIOR

Distribution Panel, USA

The low voltage distribution panel is located in the MagneTec Series 7300 Series Power Center. Open the brown door to access the panel.

All circuits are labeled on the 12-volt fuse panel.

GLASS MATT BATTERIES (Optional w/Solar Panel Charging System)

In AGM sealed batteries, the acid is absorbed between the plates and immobilized by a very fine fiberglass mat. No silica gel is necessary. This glass mat absorbs and immobilizes the acid while still keeping the acid available to the plates. This allows a fast reaction between acid and plate material.

Battery Maintenance is an important issue. The battery should be cleaned using a baking soda and water mix; a couple of table spoons to a pint of water. Cable connection needs to be clean and tightened regularly.



ELECTRICAL SYSTEM

TV ANTENNA

Manufacturer:
Winegard Company
3000 Kirkwood Street
Burlington, Iowa 52601
Phone: 800-843-4741

Raising Antenna to Operating Position

Turn elevating crank in "UP" direction until some resistance to turning is noted. Antenna is now in operating position. Check to make sure switch on front TV jack is on.

Rotating Antenna

Make sure antenna is in "UP" position. Pull down on directional handle with both hands until it disengages ceiling plate and rotate for best picture and sound on television set.

Lowering Antenna to Travel Position

Rotate antenna until pointer on directional handle aligns with pointer on ceiling plate.



WARNING: Antenna must be in "down" position while traveling to prevent damage.

Turn elevating crank in the "Down" direction until resistance is noted. Antenna is now locked in travel position.

Checking Operation

1. Tune TV receiver to nearest station and rotate antenna for best picture and sound.
2. Turn off switch on power supply. Picture on TV receiver should be considerably degraded with the power off.

DO'S

1. Do check parking location for obstructions before raising antenna.
2. Do carefully raise, lower and rotate - if difficult, check for cause.
3. Do rotate slowly when selecting station and check fine-tuning on TV set to make sure it is properly adjusted.
4. Do lower antenna before moving vehicle.

DON'TS

1. Don't force elevating crank up or down. Check for cause of trouble.
2. Don't rotate directional handle hard against stops.
3. Don't travel with lift in up position.
4. Don't leave lift part way up or down.
5. Don't apply sealing compound or paint over top of base plate or anywhere on lift.

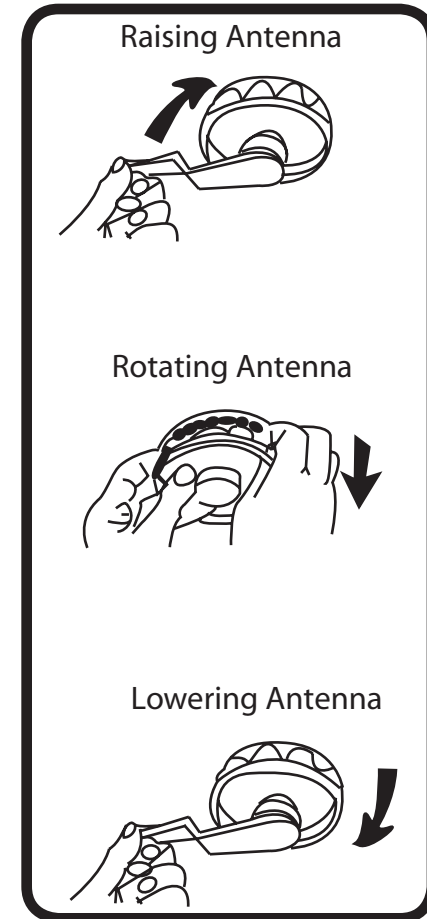

ELECTRICAL SYSTEM

Maintenance

Lubrication

To lubricate the elevating gear apply a liberal amount of silicone spray lubricant to the elevating gear with the lift in the down position, then run the lift up and down a few times to distribute lubricant over gears.

Lubricating Rotating Gear Housing

In the event that rotating the antenna becomes difficult, lubricating the bearing surface between the rotating gear housing and the base plate can restore normal operation. Any spray type silicone lubricant may be used.

Elevate antenna and remove setscrew from rotating gear housing as shown. Spray lubricant into hole and around edges of gear housing. Rotate gear housing until lubricant coats bearing surfaces and antenna rotates freely.

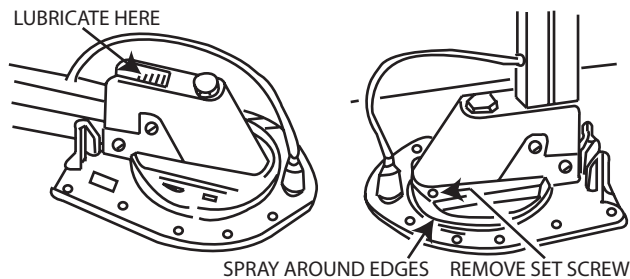

TV Booster/12 Volt Outlet

The TV booster amplifies the signal from the TV antenna. Pushing the small button activates and deactivates the booster. A green light comes on when the booster is activated. For viewing while hooked up to an exterior cable TV source, turn the booster off.

NOTE: The TV Booster must be on to receive antenna signals and off for cable TV operation.

Please review the antenna and booster manuals include in your owner's packet before operating the system.

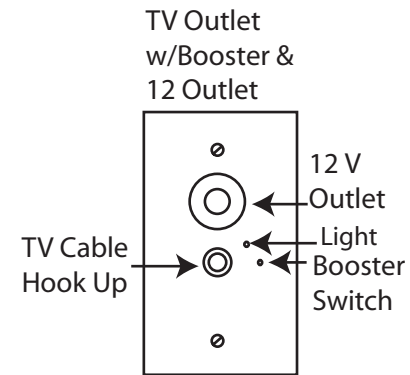

Wireless Speakers (Optional)

Your trailer may have wireless speakers which is included in the optional upgrade package. An operating guide is included with each kit.

ELECTRICAL SYSTEM

SATELLITE ANTENNA WIRING

If you compare the two diagrams you'll see wiring for a satellite dish antenna is relatively simple.

Units have a faceplate with two coax cable hook-ups. It is located on the roadside wall by the Audio/Video Center. The faceplate has a small coax cable jumper running between the hook-ups to complete the cable TV circuit when in use.

To install a satellite system use the following procedure:

1. Remove the jumper wire from the coax faceplate.
2. Hook a portable dish into the Cable TV receptacle in the roadside rear underbelly compartment. This feeds the dish signal to the input side of the faceplate.
3. Install the satellite receiver input and output into the dual coax faceplate.

To return to a cable TV system, remove the satellite receiver from the faceplate and reinstall the jumper cable.

COAXIAL CABLE WITH CABLE HOOK UP

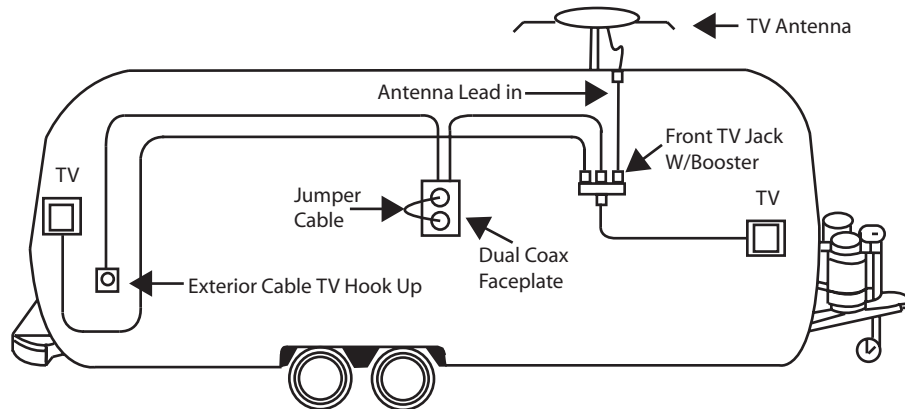

COAXIAL CABLE WITH SATELLITE HOOK UP

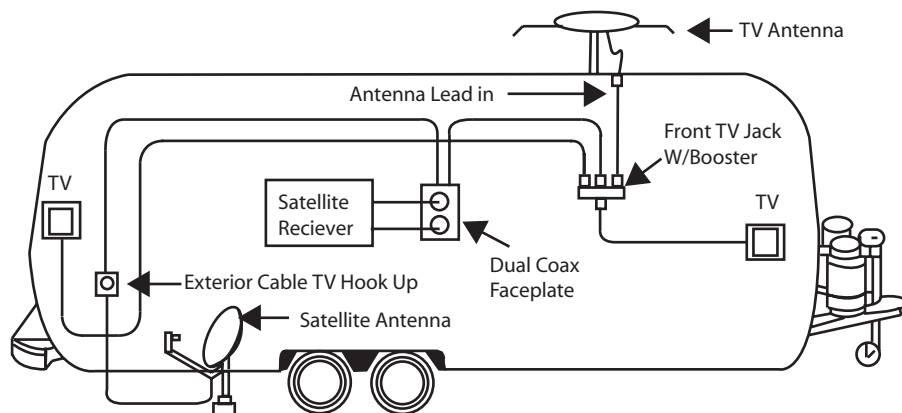

ELECTRICAL SYSTEM

SOLAR PANEL PRE-WIRE

Airstream Travel Trailers are pre-wired for an Intermountain Solar Technology Solar Panel/Charger Controller/Display System. This system may be installed on your trailer as an option. A manual on the use of the system is included with the Airstream Owner's Blue Delivery Case.

Intermountain Solar Technologies
 10288 South Jordan Gateway #D
 South Jordan, UT 84095
 800-671-0169

1. YELLOW (like the sun) positive and GREEN (like the earth) negative leads runs from battery breaker buss

bar area to a harness inside the exterior refrigerator access door. The battery buss bar is located under the roadside front dinette seat. Roof mounted panels require dropping the panel wires down through the refrigerator vent to the inside of the exterior refrigerator access door. Portable solar panels can be set outside close to the access door. The wires from the solar panel are connected to the positive and negative wires (yellow and green) of the pre-wire system.

2. A Cat 5 patch cord for the solar panel display runs from the battery buss bar to an area just below the CatCon monitor display. The solar panel display panel can be mounted just below the CatCon monitor panel by routing the proper size hole. The Cat 5 wire is plugged into the display panel.

CAUTION: The Yellow wire must be fused with a 10-amp in-line fuse at the 12-volt positive.

NOTE: All wires are identified with labels at all locations.

The Intermountain solar panel has charge controller that should be mounted close to the battery buss bars as the battery leads are hooked into it to sense the actual battery charge. The Cat 5 wire plugs into it also.

The following drawing is the way Airstream wires the system on factory installed units and is the recommended wiring for use of the pre-wire system.

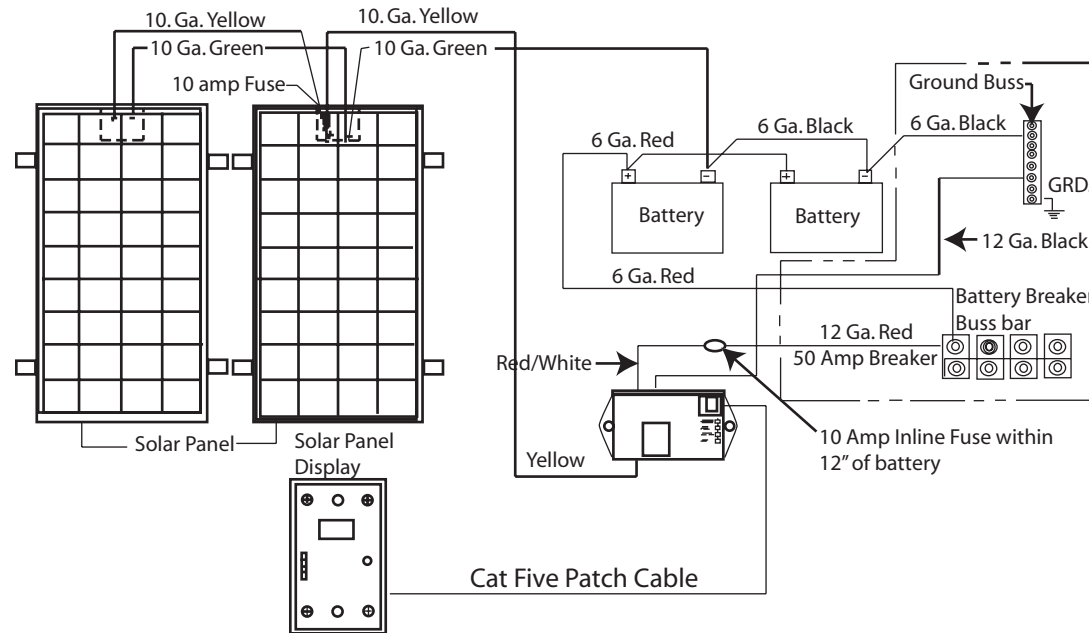

ELECTRICAL SYSTEM

BATHROOM EXHAUST FAN

Open the bath vent cover by pushing up on the handle. Press the switch to run the fan

MONITOR PANEL

Micropulse Systems Monitor

CATCON PRODUCTS INC.

817-921-2188

techsupport@catconproducts.com



The MicroPulse System makes use of a single solid-state sensor per tank. The MicroPulse sensor measures the static (head) pressure at the bottom of the tank and transmits this information to the MicroPulse System Monitor. Knowing this pressure value, after a one-time calibration has been performed, the MicroPulse System will calculate and accurately display the tank level in 1/8 increment.

A single sensor is installed on the sidewall of each tank, near the bottom, via a 3/4" female NPT spin-in thread. The sensor is solid state, there are no moving parts to wear or maintain. Because the principle of operation does not involve any electrical current flow through the tanks contents (conducted or induced), the nature of the fluid in the tank is unimportant.

The monitor system has been calibrated at the factory and should never need another calibration. If you feel the system is not operating correctly, please contact CATCON Products or a local Airstream dealer. The following instructions are provided for qualified service technicians.



ELECTRICAL SYSTEM

MICROPULSE SYSTEMS MONITOR OPERATION INSTRUCTIONS

This example shows the monitor reporting the following:

- Fresh Water = 7/8 to Full
- Gray Water 1 = Empty to 5/8
- Gray Water 2 = 3/4
- Black Water = Empty to 5/8
- Battery = Empty to 5/8

On all diagrams the Letters R=Red, Y=Yellow, G=Green, Blank=no LED lit.



NORMAL OPERATION

The MicroPulse Monitor will display the condition of each system at all times. The tri-color LED beside the system will indicate the condition of the system using the following color code.

Fresh Water and Battery are as follows:

- Green LED = 3/8 to Full
- Yellow LED = 1/4
- Red LED = 1/8 to Empty

Gray Water, Black Water are as follows:

- Green LED = Empty to 5/8
- Yellow LED = 3/4
- Red LED = 7/8 to Full

NOTE: The steel LP tanks on the International Trailer Models do have a level sensor. The monitor system does not read LP Gas levels.

TO OBTAIN EXACT READING

To obtain an exact reading of all systems press and release the status button one time. The monitor will flash the LED beside the system it is about to report. It will then display the exact condition of that system by lighting the bar graph from Empty to Full. The monitor will display the exact condition of each system and then return to normal operation mode.

To obtain an exact reading of an individual system press and release the status button until the LED beside the system that you want the condition of is lit. Release the status button and the monitor will display the exact condition of that system by lighting the bar graph from Empty.

ELECTRICAL SYSTEM

110-VOLT ELECTRICAL SYSTEM

City Power

The 110-volt electrical system provides power to operate the air conditioner, converter and 110-volt receptacles for portable appliances. The power is routed through the 110-volt city power flexible cord to the 110-volt distribution panel inside the power converter door, and then is distributed to each appliance or receptacle. 110-volt layout diagrams are shown later in this section.

A 110-volt exterior outlet for is located on the exterior wall.

CAUTION: When operating with city power make very certain that the service is 110 volt and not 220 volt.



WARNING: When the three-pronged plug can be used there will be no problems with proper polarity or grounding.

In some older parks and other locations where three pronged outlets are not available, certain precautions to insure proper grounding and polarity must be taken. These precautions are listed below:

1. Attach the three-pronged plug to a two-pronged adapter. The third conductor line of this adapter has a short wire lead, which must be grounded.
2. For proper grounding connect the short ground lead to a grounded outlet box or to a cold water pipe. When no water pipe is available drive a metal rod two feet into the ground and attach the ground lug to it, thus providing the unit with proper grounding.

To operate self-contained, simply disconnect the power supply cable.

When your trailer is hooked up to 110 volt AC, the converter system automatically charges the trailer batteries with the battery disconnect switch in the “use” (on) position and, if the 7-way cord is hooked up, your tow vehicle battery as well. The speed and degree of charge depends on how much power is used for lights and appliances, as only the surplus goes to charging the battery. If you are making an extended stay, then you should keep your trailer hooked up to a 110 volt current if it is available.

While you are connected to the 110-volt receptacle the wiring is protected by circuit breakers in the breaker panel. The circuit breaker panel for the 110-volt system is located in the converter. Open the brown decorative converter door under the dinette.

In the event of a failure of a 110-volt circuit, first check your trailer circuit breakers and the breaker for the outlet your trailer shoreline cord is plugged into. If a breaker continues to trip after you have reset it several times, your circuit may be overloaded with appliances or there may be a short in the circuit. Try lessening the load on the circuit. Perhaps an electric griddle, hair dryer, or an electric heater can be turned off. If that does not solve the problem consult an Airstream Service Center.

All wire, components, and wiring methods conform to federal and state requirements.



ELECTRICAL SYSTEM

GROUND FAULT CIRCUIT INTERRUPTER (GFCI)

Many states require trailers which are sold in their state, and which have exterior 110 volt receptacles, to have a ground fault circuit interrupter.

Trailers manufactured for sale in these states have type THQL 15 amp GFCI breakers installed on the general circuit, since the exterior breaker is on this circuit. The breaker replaced the standard TQL-15 amp breaker.

When properly installed, the GFCI circuit breaker provides reliable overload and short circuit protection PLUS protection from Ground Faults that might result from contact with a "HOT" load wire and ground.

IMPORTANT NOTE: The GFCI circuit breaker will NOT reduce shock hazard if contact is made between a "HOT" load wire and a neutral wire or 2 "HOT" load wires.

Each GFCI circuit breaker is calibrated to trip with a ground current of 5 milliamperes or more. Since most persons can feel as little as 2 milliamperes, a distinct shock may be felt if the need for protection exists. However, the shock should be of such short duration that the effects would be reduced to less than the normally dangerous level. However, persons with acute heart problems or other conditions that can make a person particularly susceptible to electric shock may still be seriously injured.

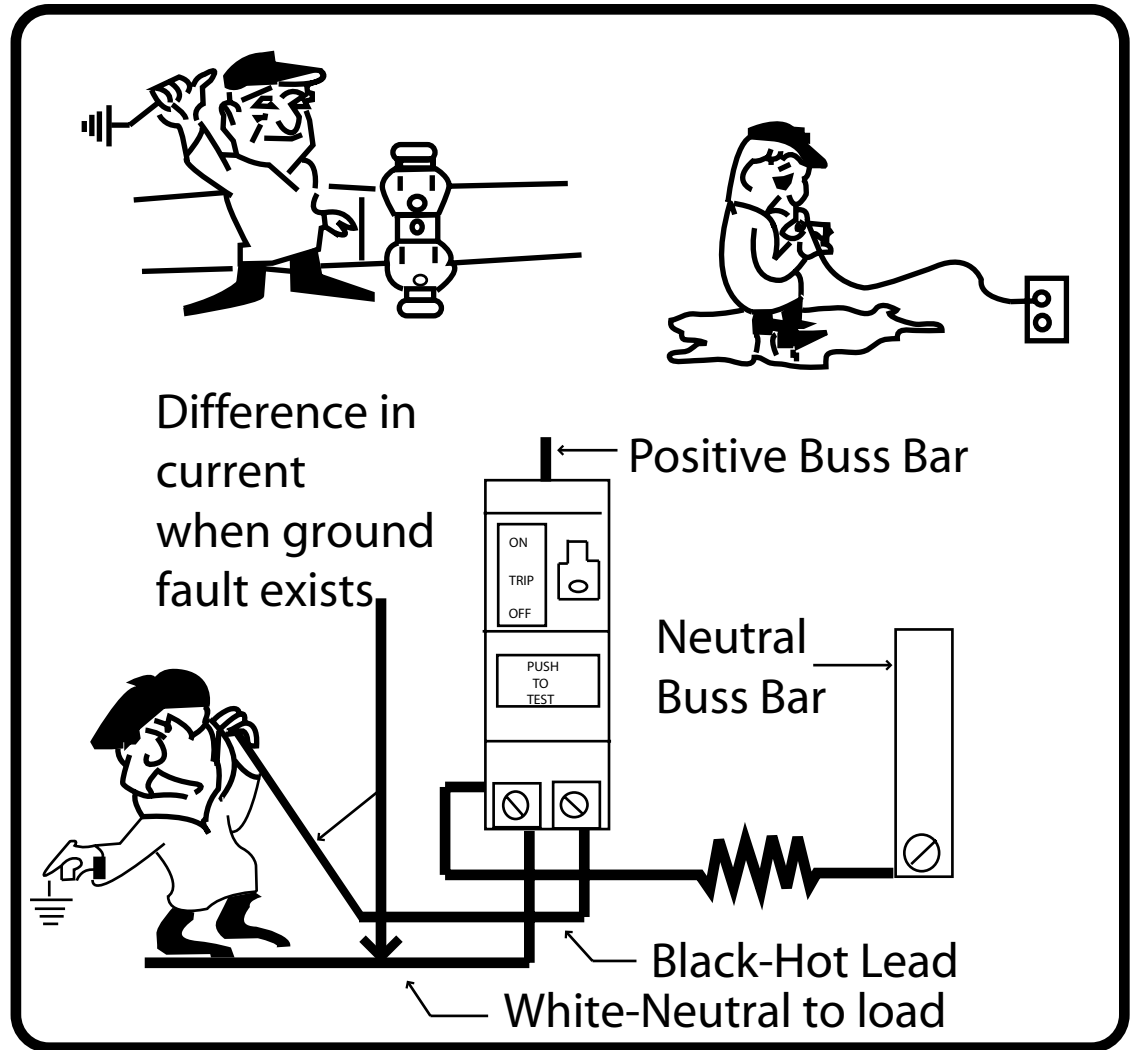

ELECTRICAL SYSTEM

While the GFCI circuit breaker affords a high degree of protection, there is no substitute for the knowledge that electricity can be dangerous when carelessly handled or used without reasonable caution.



WARNING: The GFCI circuit breaker provides protection only to the circuit to which it is connected. It does NOT provide protection to any other circuit.

OCCUPANT:

Make this test each month and record the date on the chart.

1. With handle B in "ON" position, press PUSH TO TEST button A.
2. Handle B should move to TRIP position, indicating that GFCI breaker has opened the circuit.
3. To restore power move handle B to "OFF" and the to "ON"

Important: If handle B does not move to TRIP position when test button is pressed, the GFCI breaker protection is not complete. If this happens, replace GFCI breaker.

	JAN	FEB	MAR	APR	MAY	JUN	JUL	AUG	SEP	OCT	NOV	DEC
2006												
2007												
2008												
2009												
2010												
2011												



APPLIANCES



WARNING: The operation manual for all appliances is included with the owner's packet. Their manuals may contain specialized warnings and cautions specific to your appliances that should be reviewed prior to operating the appliance. If a manual is missing and has not been provided with your trailer, contact the appliance manufacturer, your Airstream Dealer, or Airstream Customer Service to obtain it.



WARNING: Most LP gas appliances used in recreational vehicles are vented to the outside of the vehicle. When parked close to a gasoline pump, it is possible that gasoline fumes could enter this type of appliance and ignite the burner flame, CAUSING A FIRE OR AN EXPLOSION.

AIR CONDITIONER

Manufacturer:

Dometic Sales Corporation
2320 Industrial Parkway P.O. Box 490
Elkhart, IN 46515
Phone: 219-295-5228

Note: Review the air conditioning literature supplied in your Owner's Packet before proceeding,

The roof air conditioner used on Airstream trailers is one of the most popular on the market today. In your Owner's Packet is a set of literature covering all operating and maintenance instructions. If the literature is misplaced please contact the air conditioner manufacturer or your Airstream dealer for replacement.

The voltage to the air conditioner is critical. We commonly refer to 110 or 120 volts, but a check with a voltmeter may find voltage much lower. Your air conditioner will probably not function if the current drops below 105 volts. Low voltage is usually associated with older or poorly maintained trailer parks, but many people have found their homes, built only twenty or thirty years ago, may not be capable of operating the air conditioner on some receptacles. Parking your trailer so the power cord can be plugged into a receptacle close to the fuse or circuit breaker box can alleviate the problem. Avoid extension cords and adapters whenever possible. If an extension cord must be used it should be as short and heavy as possible to provide the most current to the air conditioner.

If high temperatures are expected, you should make an effort to park in a shaded area. Starting the air conditioner early in the morning also helps. It is much easier to hold a comfortable temperature than it is to lower the temperature after the interior of the trailer is already hot.

FURNACE

Manufacturer:

Hydro Flame Corporation 1874

South Pioneer Road

Salt Lake City, UT 84104

Phone: 801-972-4621

The manufacturer of the furnace in your trailer has been well known in the RV industry for many years. The furnace burns LP gas, and is powered by 12 volt current from the battery or power converter when plugged into city power. Operating instructions are located in your Owners Packet. If they should become misplaced new literature can be ordered direct from the manufacturer or your Airstream dealer. The manufacturer also offers a detailed service guide for your furnace.

If warranty service is required contact your Airstream dealer or a service location recommended by the furnace manufacturer.



WARNING: Carefully read all the manufacturer's instructions prior to operating. **NEVER** store flammable material next to the furnace or it's exterior vents.

3-BURNER RANGE W/OVEN

Manufacturer:

Magic Chef

28812 Phillips Street

Elkhart, Indiana 46514

219-264-9578

People using gas ranges in their home will find little difference in the operation of the range in a recreation vehicle. Other customers, used to electric ranges may be a little apprehensive at first; but will quickly gain confidence. The basic operation of the gas ranges have been the same for many years, but please be sure to read all the directions furnished by the manufacturer and located in the Owner's Packet. Excellent service and parts manuals are available from the manufacturer.

APPLIANCES

REFRIGERATOR

Manufacturer:

Dometic Sales Corporation 2320

Industrial Parkway P.O. Box 490

Elkhart, Indiana 46514

Phone: 219-295-5228

Review all Dometic Literature supplied in your Owner's Packet or stored in the refrigerator prior to operating.

In an absorption refrigerant system ammonia is liquefied in the finned condenser coil at the top rear of the refrigerator. The liquid ammonia then flows into the evaporator (inside the freezer section) and is exposed to a circulating flow of hydrogen gas, which causes the ammonia to evaporate, creating a cold condition in the freezer.

The tubing in the evaporator section is specifically sloped to provide a continuous movement of liquid ammonia, flowing downward by gravity, through this section. If the refrigerator is operated out-of-level when the vehicle is not moving, liquid ammonia will accumulate in portions of the evaporator tubing. This will slow the circulation of hydrogen and ammonia gas, or in severe cases, completely block it, resulting in a loss of cooling.

Any time the vehicle is parked for several hours with the refrigerator operating the vehicle should be leveled to prevent this loss of cooling. The vehicle needs to be leveled only so it is **comfortable to live in** (no noticeable sloping of floor or walls).

When the vehicle is moving the leveling is not critical, as the rolling and pitching movement of the vehicle will pass to either side of level, keeping the liquid ammonia from accumulating in the evaporator tubing.

OPERATION

The refrigerator requires 12-volt current to operate its electronic board even if running on LP or 110-volt modes. The 12-volt is used to power the circuit board that directs the refrigerator functions. When running in the LP mode the heat source used to evaporate the ammonia, by far the largest power requirement; is being provided by an LP Gas burner.

WATER HEATER

Manufacturer:

Atwood Mobile Products 4750

Hiawatha Drive P.O. Box 1205

Rockford, Illinois 61105

Phone: 815-877-7461

Note: Review the water heater literature supplied in your Owner's Packet before proceeding,

CAUTION: Hydrogen gas can be produced in a hot water system served by this heater that has not been used for a long period of time (generally two weeks or more). Hydrogen gas is extremely flammable. To reduce the risk of injury under these conditions, it is recommended that the hot water faucet be opened for several minutes at the kitchen sink before using any electrical appliance connected to the hot water system. If hydrogen is present there will probably be an unusual sound such as air escaping through the pipe as the water begins to flow. There should be no smoking or open flame near the faucet at the time it is open.

SAFETY

If your water system is full and cold and the water heater is ignited the system can see pressures as high as 120 psi before the relief valve starts to open. Since the water system normally operates in the 40-psi range the water expanding does put unusual stress on the system. This normally does not cause any problems, but the stress is easily alleviated. As the water is heating just open any faucet and run as little as a cup of water. Just removing this small amount of water reduces the pressure build up significantly.

For fun, watch the sequence of events your family goes through when you park the trailer **and ignite the water heater. More than likely someone will run water and relieve the pressure without even realizing it.**

Water Heater Draining

All models have a drain plug or petcock on the water heater. Access is from the exterior. The plug or valve is usually located in the lower left corner, viewed as you face the exterior of the water heater.



APPLIANCES

HIGH VOLUME ROOF VENT

Manufacturer:

FAN-TASTIC VENT CORP.

4349 S. Dort Hwy.

Burton, MI 48529

1-313-742-0330

1-800-521-0298

The optional High-volume roof vent system is designed to quickly exhaust stale, hot air and draw in fresh air. It's great to use when the outside temperature really doesn't call for air conditioning, but heat has built up in your coach.

OPERATING INSTRUCTIONS:

- 1) Open dome approx. 3" or more (ceiling fan has a built in safety switch that will not allow motor to operate unless dome is partially open).
- 2) Turn 3- speed knob to desired performance lever (3-Low, 2-Medium, 1-High, 0-Off)
- 3) Open a window or door for airflow,
- 4) Source of airflow is determined by the window(s) or door(s) opened. For best results, close all roof vents and open 1 (one) window the greatest distance from your Fan-Tastic Vent ceiling fan,

CAUTION: Never place Lindeen™ or a like cover over ceiling fan. Greatly restricted airflow & increased sound levels will occur.

WHEN EQUIPPED WITH REVERSE SWITCH

- 1) Turn fan motor off by:
 - a) Setting 3-speed switch to "O" - OFF. b) Closing Dome. c) Selecting center position on IN/OUT rocker switch
- 2) Wait for fan blade to stop.
- 3) Select IN position brings air from the roof area into your coach (pressurizes inside).
- 4) Or select OUT position, brings air in through any or all openings in coach and exhausts through the roof.
- 5) Turn fan motor On.

WHEN EQUIPPED WITH THERMOSTAT:

- 1) Follow "Operating Instructions: 1 thru 4
- 2) Select desired temperature or comfort level on thermostat. Fan motor will now start & stop automatically as interior temperature of coach exceeds or drops below selected level.

NOTE: Fan motor will not start if temperature selected is warmer than interior temperature of coach.

CLEANING INSTRUCTIONS:

- 1) Turn fan motor Off.
- 2) Remove 8 painted flat head Phillips screws around perimeter of screen insert only.
- 3) Clean screen with soap & water solution, dry, and reinstall.

NOTES



SPECIFICATIONS

Note: All weights on the next page were made on prototype vehicles. Your production trailer may vary. For the weight specifications of your trailer read the weight label (see location information under “Loading” section of this manual) and check the manufacturing tag on the side of your trailer.

The Unit Base Weight (UBW) and the Net Carrying Capacity (NCC) is not the same as the Unloaded Vehicle Weight (UVW) and the Cargo Carrying Capacity (CCC) shown on the Trailer Weight Information tag in your vehicle. The UBW and NCC weights are for the base unit with no options and fluids. The UVW and CCC on the Trailer Weight Information tag are weights for the individual vehicle as built with its options and certain water capacities.

Recommended Cold Tire Inflation Pressure

ST 225/75R-15 65 PSI

Gross Vehicular Weight Rating (GVWR): is the maximum permissible weight of this trailer when fully loaded. It includes all weight at the trailer axle (s) and tongue or pin.

Unit Base Weight (**UBW**): is the dry weight of the base unit with bedroom group and without options.

Net Carrying Capacity (**NCC**): is equal to GVWR minus UBW

Gross Axle Weight Rating (**GAWR**): is the value specified as the load carrying capacity of a single axle system, as measured at the tire-ground interfaces.

GAWR Gross Axle Weight ratings are located on the manufacturing tag that is positioned on the roadside side sheet of your travel trailer.

SPECIFICATIONS

DESCRIPTION	SPECIFICATION
Exterior Length	19' 2"
Exterior Width	8'
Interior Width	7' 7"
Exterior Height W / AC	9' 5"
Exterior Height W/O AC	8' 9"
Interior Height W/AC	6' 4.5"
Interior Height W/O AC	6' 7"
*Hitch Ball Height	17.25"
**Hitch Wt. (lbs.)	530
GVWR (lbs.)	4, 500
NCC (lbs.)	820
UBW (lbs.)	3,680
LPG (lbs.) 2 Bottles	30 each
Tire Size	ST225/ 75R15
Fresh water (gal.)	23
Gray water (gal.)	21
Black water (gal.)	18

*Hitch Ball Height

The proper height will vary according to the weight you carry and the tires you use. However, checking the height on your trailer is relatively easy:

1. With trailer on fairly level ground measure from ground to bottom of frame, front and rear.
2. Adjust front jack until measurements are equal.
3. Now measure from ground to the inside top of ball coupler. This figure is the hitch height. The hitch ball is then usually set ½" to 1" higher, according to the spring weight of your tow vehicle, to allow for it to settle when the trailer is hitched up.

** Without options or variable weight.

INDEX

Accessories	B-12	Condensation	C-8	Faucets	F-8
Air Conditioner	H-1	Converter	E-4, G-3	Filter, Water Pump	F-5
Alignment	A-4, D-4	Connector		Fire Extinguisher	E-9
Antennas	G-6	7-Way	B-2	Flat Tire	C-3, D-7
Appliances	H-1	110-volt	C-4, E-4, G-12	Furnace	H-2
Axles	D-4	Countertop	E-2	Fuses	A-8, E-8, G-1, G-4, G-9
Awning	D-2	Coupler	D-3		
		Control Panel	E-3, F-12, G-10	Galley	E-2
Backing	B-10			Gas, LP	C-1, E-8, F-1
Battery	G-1	Dimensions	I-2	Gas Regulator	F-2
Battery Disconnect	E-4, G-1, G-12	Dinette	E-2	Grey Tank (Aux)	F-12, I-2
Bath Exhaust	E-3	Doors		Ground Fault Interrupter	G-13
Bathroom	E-3	Main	D-2	Grounding	G-12
Bearing	D-5	Screen	D-2	GVWR	I-2
Black Tank Flush	F-13	Drain Valves	F-9	GAWR	B-5, I-2
Bottles, LP	F-2	Drainage	F-9		
Brake Controller	D-6	Dump Valves	F-12	Hitch	B-1, B-4, B-6, I-2
Brakes	B-1, D-6			Hitching Up	B-5
Breakaway Switch	B-2, D-6	Electrical	G-1	Hitch Weight	B-5, I-2
Bulbs	A-8	12 Volt	G-1	Holding Tanks	F-12, I-2
		110 Volt	C-4, G-12	Hitch Ball Height	B-7, D-3, I-2
Camping	C-1	Circuit Breakers	G-1, G-12		
Carbon Monoxide Detector	E-10	Diagrams		Humidity	C-8
Capacities	I-2	Coax, TV cable	G-8		
Cargo	B-4, E-4	Solar panel	G-9	Interior	E-1
Caution	Introduction	7-Way Cable	B-2		
Chassis	D-3	Escape Window	C-1, D-2, E-9	Jacks	
Check List	B-12	Exhaust Fans	E-3, G-10, H-5	Stabilizing	C-2, C-3
City Water Hook-Up	C-4, F-7	Extended Stay	C-3	Tire Changing	D-7
Cleaning	D-1	Exterior Maintenance	D-1		
Circuit Breakers	G-1, G-12	Factory Service	A-5		
Coaxial Cable Wiring	G-8	Fans	E-3, G-10, H-5		

INDEX

Lavatory.....	E-2	Satellite TV wiring and hook up.....	C-5	Upholstery.....	E-1
Length, Trailer.....	I-2	Screens.....	D-2	Valves, Drain.....	F-9
Leveling.....	C-3	Service.....	A-5	Vents.....	E-4, H-5
Lights.....	E-4	Sewer Hose.....	C-4, F-12	Warning.....	Introduction
Loading.....	B-4, E-4	Shower.....	E-2	Warranty.....	A-1
LP Bottles.....	F-1	Sink.....	E-2	Washing.....	D-1
LP Gas.....	C-7, E-3, F-1	Smoke Alarm.....	E-5	Waste System.....	F-12
LP Gas Detector.....	E-8	Solar Panel.....	G-5, G-9	Water System.....	F-5
Maintenance Parts.....	A-8	Specifications.....	I-2	Drainage.....	F-9
Maintenance Record.....	A-9	Stabilizing.....	C-2	Filter.....	F-5
Maintenance Schedule.....	A-6	Step.....	B-7, D-2	Heater.....	C-4, E-3, F-5, F-9, H-4
Mold Prevention.....	C-9	Storage.....	B-3, E-4, F-10	Inlet Connection.....	C-4, F-7
Monitor Panel.....	E-3, F-12, G-10	Stove.....	H-2	Pump.....	E-3, F-5
Oven.....	H-2	Suspension.....	D-4	Strainer.....	F-5
Overnight Stop.....	C-2	Table.....	E-2	Tank.....	F-5, F-9, I-2
Parking.....	C-2	Tires.....	D-7, I-2	Valves.....	F-6, F-9
Passing.....	B-9	Changing.....	D-7	Waxing.....	D-1
Plumbing.....	F-1	Loading/Inflation.....	D-9	Weight.....	B-3, I-2
Power Cord.....	C-4, G-12	Overloading.....	D-9	Weight Distribution.....	B-3, B-6
Power Jack.....	D-3	Rotation, Tire.....	D-8	Wheel	
Range.....	H-2	Tongue Latch.....	D-3	Torque.....	D-7
Refrigerator.....	H-3	Tongue Weight.....	B-5	Alignment.....	A-4, D-4, I-1
Regulator, LP.....	F-2	Toilet.....	F-14	Bearing.....	D-5
Roof Vents.....	E-3, H-5, G-10	Towing.....	B-1	Windows.....	C-1, D-2, E-9
Safety.....	A-5, C-1, E-5, E-8, E-9, F-3	Tow Vehicle.....	B-1	Winter Traveling.....	C-7
Safety Chains.....	B-7	TV.....	C-5	Winterizing.....	F-10
Sanitizing.....	F-6	TV Antenna.....	G-6		
Satellite Radio Option.....	E-10				